

MITSUBISHI HVIGBT MODULES  
**CM600HG-90H**

3rd-Version HVIGBT (High Voltage Insulated Gate Bipolar Transistor) Modules

HIGH POWER SWITCHING USE  
**INSULATED TYPE**

**CM600HG-90H**



- IC ..... 600 A
- VCES ..... 4500 V
- High Insulated Type
- 1-element in a Pack
- AISiC Baseplate

**APPLICATION**

Traction drives, High Reliability Converters / Inverters, DC choppers

**OUTLINE DRAWING & CIRCUIT DIAGRAM**

Dimensions in mm

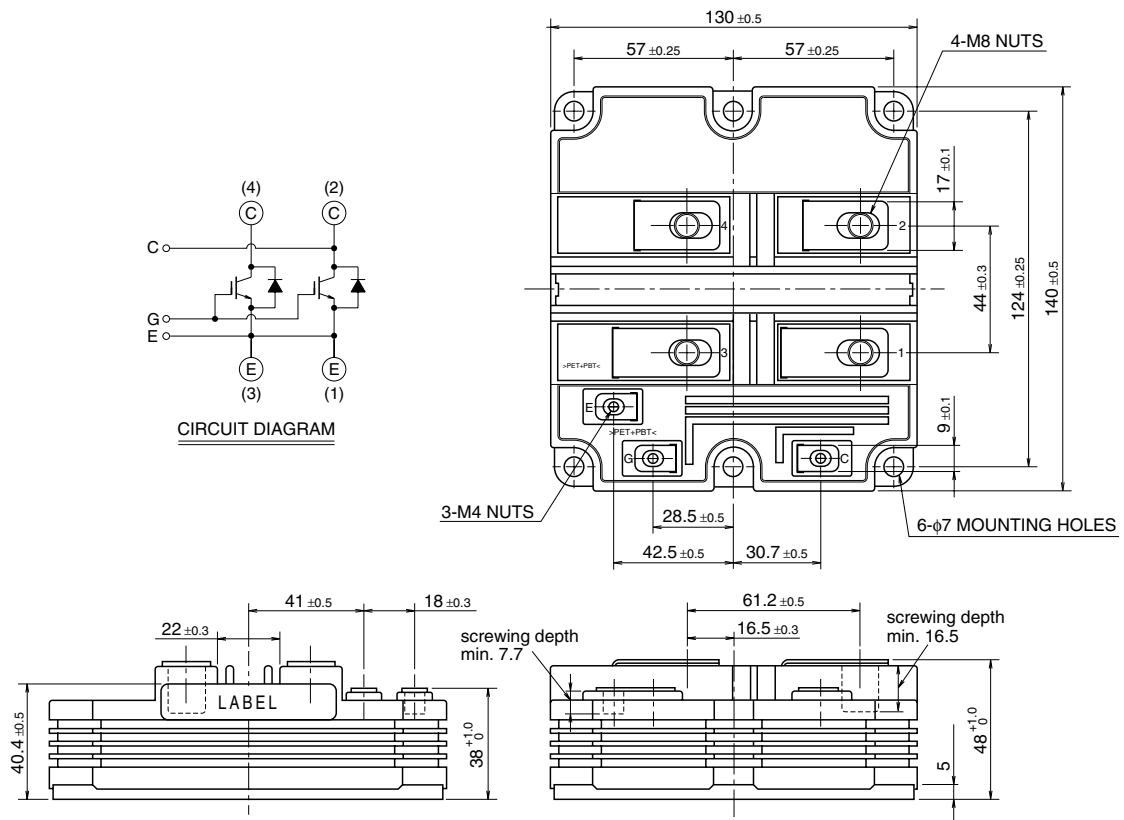

HVIGBT (High Voltage Insulated Gate Bipolar Transistor) Modules

May 2009

**CM600HG-90H**

**HIGH POWER SWITCHING USE  
INSULATED TYPE**

3rd-Version HVIGBT (High Voltage Insulated Gate Bipolar Transistor) Modules

**MAXIMUM RATINGS**

Symbol	Item	Conditions	Ratings	Unit
V <sub>CES</sub>	Collector-emitter voltage	V <sub>GE</sub> = 0V, T <sub>J</sub> = 25°C	4500	V
V <sub>GES</sub>	Gate-emitter voltage	V <sub>CE</sub> = 0V, T <sub>J</sub> = 25°C	± 20	V
I <sub>C</sub>	Collector current	DC, T <sub>c</sub> = 100°C	600	A
I <sub>CM</sub>		Pulse (Note 1)	1200	A
I <sub>E</sub>	Emitter current (Note 2)	DC	600	A
I <sub>EM</sub>		Pulse (Note 1)	1200	A
P <sub>c</sub>	Maximum power dissipation (Note 3)	T <sub>c</sub> = 25°C, IGBT part	7500	W
V <sub>iso</sub>	Isolation voltage	RMS, sinusoidal, f = 60Hz, t = 1 min.	10200	V
V <sub>e</sub>	Partial discharge extinction voltage	RMS, sinusoidal, f = 60Hz, Q <sub>PD</sub> ≤ 10 pC	5100	V
T <sub>J</sub>	Junction temperature		-40 ~ +150	°C
T <sub>op</sub>	Operating temperature		-40 ~ +125	°C
T <sub>stg</sub>	Storage temperature		-40 ~ +125	°C
t <sub>psc</sub>	Maximum short circuit pulse width	V <sub>CC</sub> = 3200V, V <sub>CE</sub> ≤ V <sub>CES</sub> , V <sub>GE</sub> = 15V, T <sub>J</sub> = 125°C	10	μs

**ELECTRICAL CHARACTERISTICS**

Symbol	Item	Conditions	Limits			Unit
			Min	Typ	Max	
I <sub>CES</sub>	Collector cutoff current	V <sub>CE</sub> = V <sub>CES</sub> , V <sub>GE</sub> = 0V T <sub>J</sub> = 25°C T <sub>J</sub> = 125°C	—	—	3.5 35	mA
V <sub>GE(th)</sub>	Gate-emitter threshold voltage	V <sub>CE</sub> = 10 V, I <sub>C</sub> = 60 mA, T <sub>J</sub> = 25°C	5.0	6.0	7.0	V
I <sub>GES</sub>	Gate leakage current	V <sub>GE</sub> = V <sub>GES</sub> , V <sub>CE</sub> = 0V, T <sub>J</sub> = 25°C	—	—	0.5	μA
C <sub>ies</sub>	Input capacitance	V <sub>CE</sub> = 10 V, V <sub>GE</sub> = 0 V, f = 100 kHz, T <sub>J</sub> = 25°C	—	108	—	nF
C <sub>oes</sub>	Output capacitance		—	8	—	nF
C <sub>res</sub>	Reverse transfer capacitance		—	2.4	—	nF
Q <sub>g</sub>	Total gate charge	V <sub>CC</sub> = 2250 V, I <sub>C</sub> = 600 A, V <sub>GE</sub> = ±15 V, T <sub>J</sub> = 25°C	—	10	—	μC
V <sub>CE(sat)</sub>	Collector-emitter saturation voltage	I <sub>C</sub> = 600 A (Note 4) V <sub>GE</sub> = 15 V T <sub>J</sub> = 25°C T <sub>J</sub> = 125°C	—	3.45 3.70	—	V
t <sub>d(on)</sub>	Turn-on delay time	V <sub>CC</sub> = 2250 V, I <sub>C</sub> = 600 A, V <sub>GE</sub> = ±15 V R <sub>G</sub> = 15 Ω, T <sub>J</sub> = 125°C, L <sub>S</sub> = 120 nH	—	—	2.40	μs
t <sub>r</sub>	Turn-on rise time		—	—	1.20	μs
E <sub>on(10%)</sub>	Turn-on switching energy (Note 5)	Inductive load	—	2.80	—	J/P
t <sub>d(off)</sub>	Turn-off delay time	V <sub>CC</sub> = 2250 V, I <sub>C</sub> = 600 A, V <sub>GE</sub> = ±15 V R <sub>G</sub> = 15 Ω, T <sub>J</sub> = 125°C, L <sub>S</sub> = 120 nH	—	—	6.00	μs
t <sub>f</sub>	Turn-off fall time		—	—	1.20	μs
E <sub>off(10%)</sub>	Turn-off switching energy (Note 5)	Inductive load	—	1.70	—	J/P
V <sub>EC</sub>	Emitter-collector voltage (Note 2)	I <sub>E</sub> = 600 A (Note 4) V <sub>GE</sub> = 0 V T <sub>J</sub> = 25°C T <sub>J</sub> = 125°C	—	4.80 4.15	—	V
t <sub>rr</sub>	Reverse recovery time (Note 2)	V <sub>CC</sub> = 2250 V, I <sub>E</sub> = 600 A, V <sub>GE</sub> = ±15 V R <sub>G</sub> = 15 Ω, T <sub>J</sub> = 125°C, L <sub>S</sub> = 120 nH Inductive load	—	—	1.80	μs
Q <sub>rr</sub>	Reverse recovery charge (Note 2)		—	610	—	μC
E <sub>rec(10%)</sub>	Reverse recovery energy (Note 2), (Note 5)		—	0.67	—	J/P

**CM600HG-90H**

**HIGH POWER SWITCHING USE  
INSULATED TYPE**

3rd-Version HVIGBT (High Voltage Insulated Gate Bipolar Transistor) Modules

**THERMAL CHARACTERISTICS**

Symbol	Item	Conditions	Limits			Unit
			Min	Typ	Max	
$R_{th(j-c)Q}$	Thermal resistance	Junction to Case, IGBT part	—	—	16.5	K/kW
$R_{th(j-c)R}$	Thermal resistance	Junction to Case, FWDi part	—	—	33.0	K/kW
$R_{th(c-f)}$	Contact thermal resistance	Case to Fin, $\lambda_{grease} = 1W/m-K$ , $D(c-f) = 100 \mu m$	—	9.0	—	K/kW

**MECHANICAL CHARACTERISTICS**

Symbol	Item	Conditions	Limits			Unit
			Min	Typ	Max	
$M_t$	Mounting torque	M8: Main terminals screw	7.0	—	15.0	N·m
$M_s$		M6: Mounting screw	3.0	—	6.0	N·m
$M_t$		M4: Auxiliary terminals screw	1.0	—	3.0	N·m
m	Mass		—	1.00	—	kg
CTI	Comparative tracking index		600	—	—	—
$d_a$	Clearance		26	—	—	mm
$d_s$	Creepage distance		56	—	—	mm
$L_{PCE}$	Internal inductance		—	27	—	nH
$R_{CC+EE}$	Internal lead resistance	$T_c = 25^\circ C$	—	0.19	—	mΩ

- Note 1. Pulse width and repetition rate should be such that junction temperature ( $T_j$ ) does not exceed  $T_{opmax}$  rating (125°C).  
 2. The symbols represent characteristics of the anti-parallel, emitter to collector free-wheel diode (FWDi).  
 3. Junction temperature ( $T_j$ ) should not exceed  $T_{jmax}$  rating (150°C).  
 4. Pulse width and repetition rate should be such as to cause negligible temperature rise.  
 5.  $E_{on(10\%)} / E_{off(10\%)} / E_{rec(10\%)}$  are the integral of  $0.1V_{CE} \times 0.1I_C \times dt$ .

**CM600HG-90H**

**HIGH POWER SWITCHING USE  
INSULATED TYPE**

3rd-Version HVIGBT (High Voltage Insulated Gate Bipolar Transistor) Modules

**PERFORMANCE CURVES**

**OUTPUT CHARACTERISTICS  
(TYPICAL)**

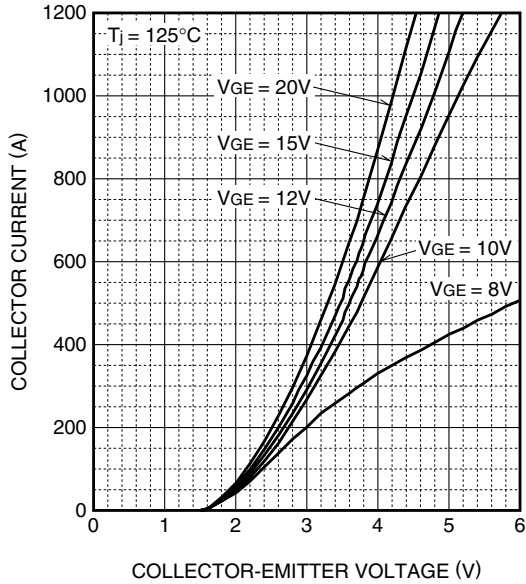

**TRANSFER CHARACTERISTICS  
(TYPICAL)**

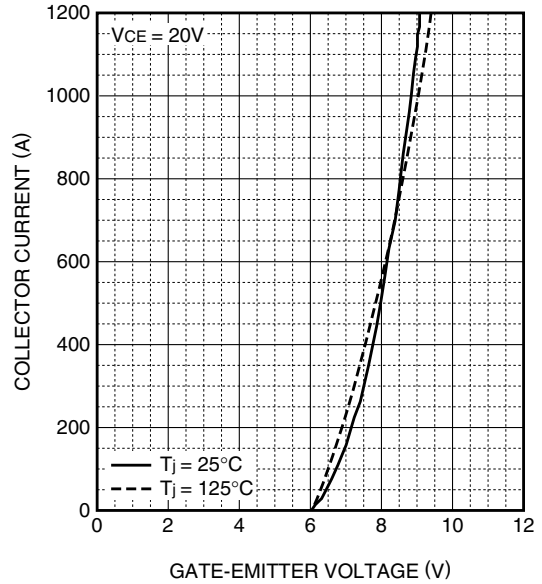

**COLLECTOR-EMITTER SATURATION  
VOLTAGE CHARACTERISTICS  
(TYPICAL)**

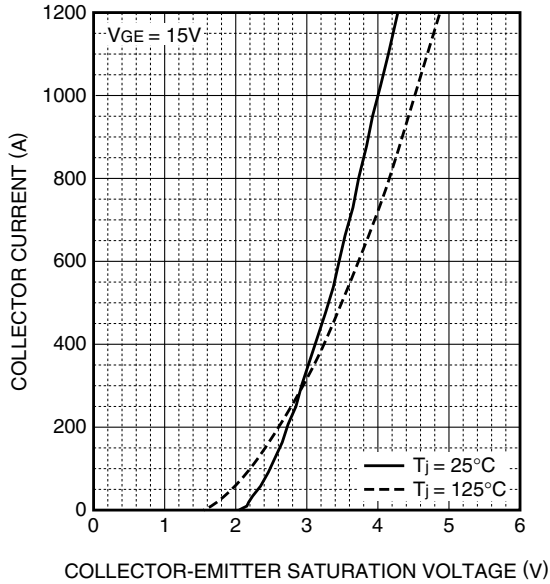

**FREE-WHEEL DIODE  
FORWARD CHARACTERISTICS  
(TYPICAL)**

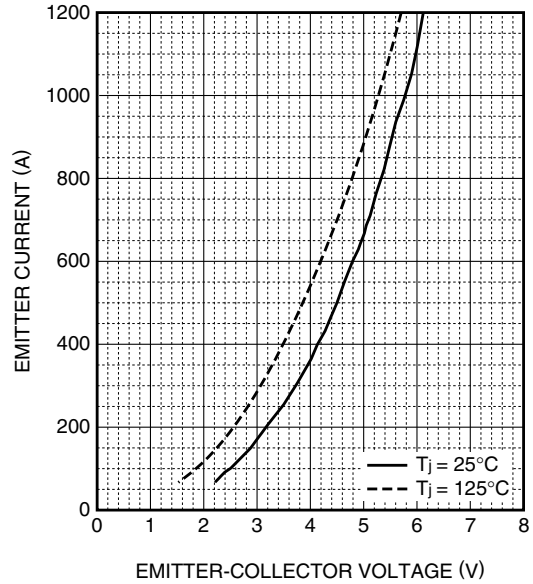

# CM600HG-90H

HIGH POWER SWITCHING USE  
INSULATED TYPE

3rd-Version HVIGBT (High Voltage Insulated Gate Bipolar Transistor) Modules

**CAPACITANCE CHARACTERISTICS  
(TYPICAL)**

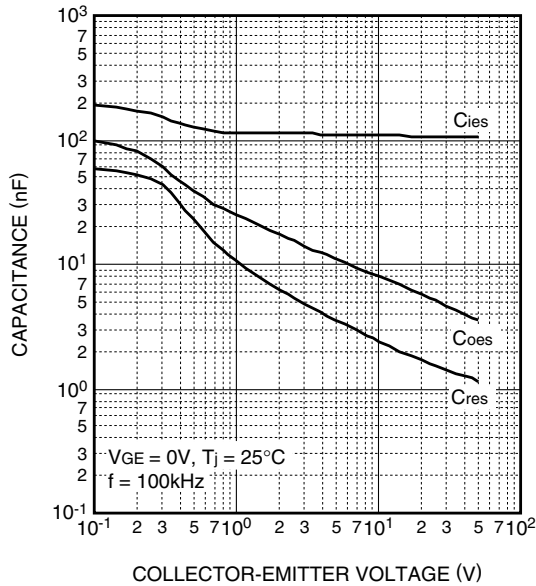

**GATE CHARGE CHARACTERISTICS  
(TYPICAL)**

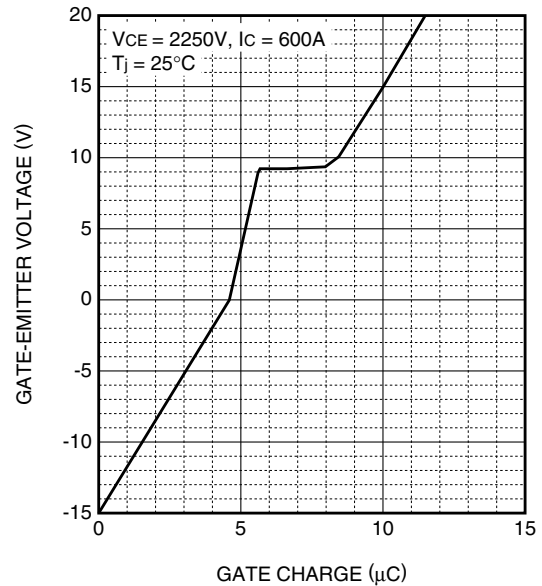

**HALF-BRIDGE SWITCHING ENERGY  
CHARACTERISTICS  
(TYPICAL)**

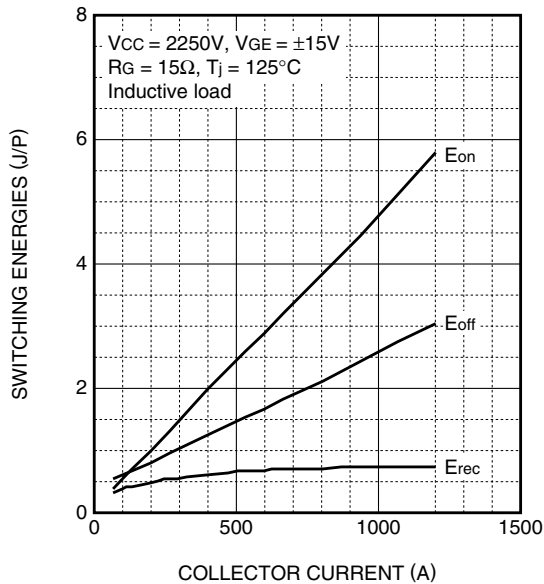

**HALF-BRIDGE SWITCHING ENERGY  
CHARACTERISTICS  
(TYPICAL)**

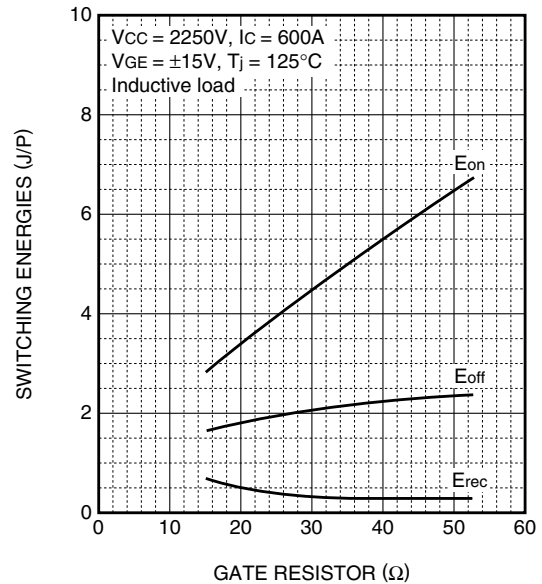

# CM600HG-90H

HIGH POWER SWITCHING USE  
INSULATED TYPE

3rd-Version HVIGBT (High Voltage Insulated Gate Bipolar Transistor) Modules

**HALF-BRIDGE SWITCHING TIME CHARACTERISTICS (TYPICAL)**

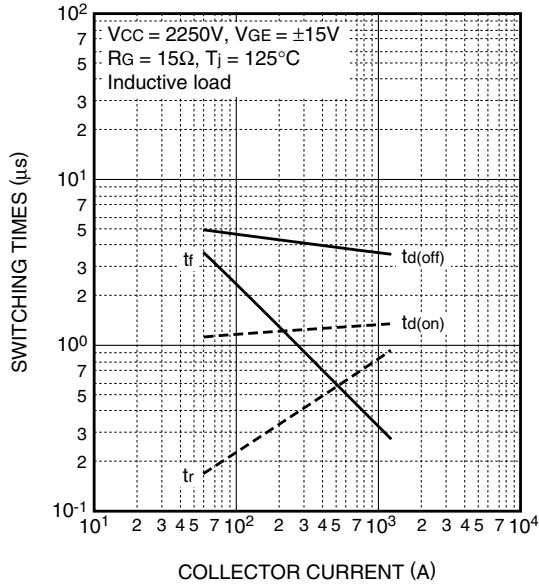

**FREE-WHEEL DIODE REVERSE RECOVERY CHARACTERISTICS (TYPICAL)**

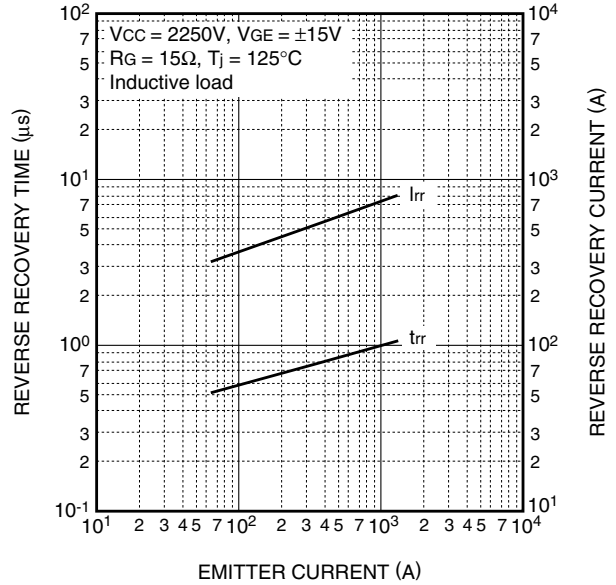

**TRANSIENT THERMAL IMPEDANCE CHARACTERISTICS**

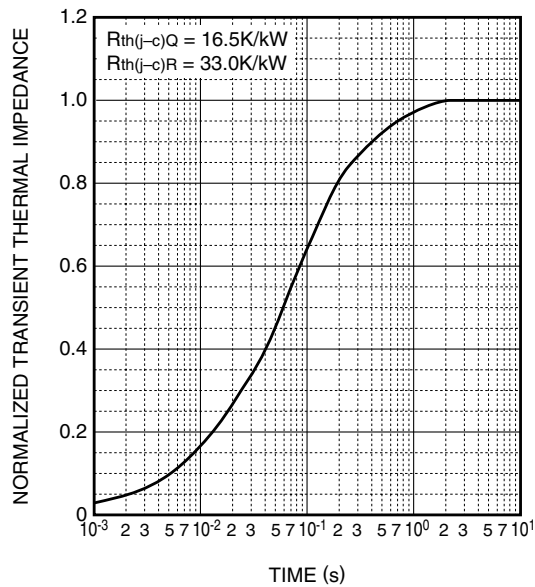

$$Z_{th(j-c)}(t) = \sum_{i=1}^n R_i \left\{ 1 - \exp\left(-\frac{t}{\tau_i}\right) \right\}$$

	1	2	3	4
$R_i$ [K/kW]	0.0059	0.0978	0.6571	0.2392
$\tau_i$ [sec]	0.0002	0.0074	0.0732	0.4488

**CM600HG-90H**

**HIGH POWER SWITCHING USE  
INSULATED TYPE**

3rd-Version HVIGBT (High Voltage Insulated Gate Bipolar Transistor) Modules

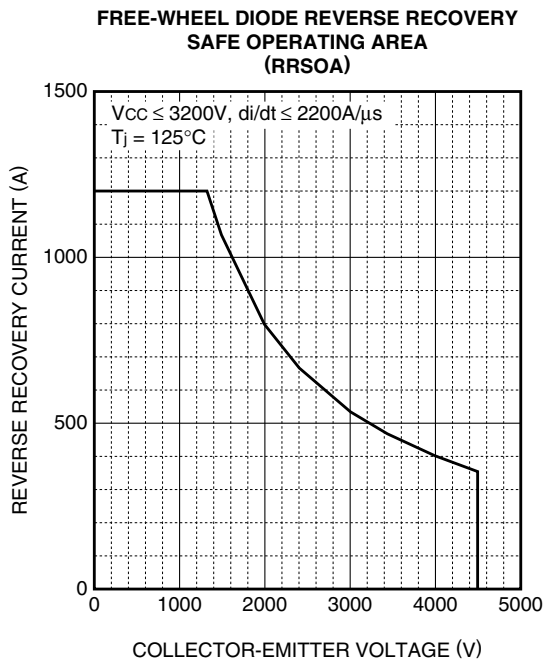
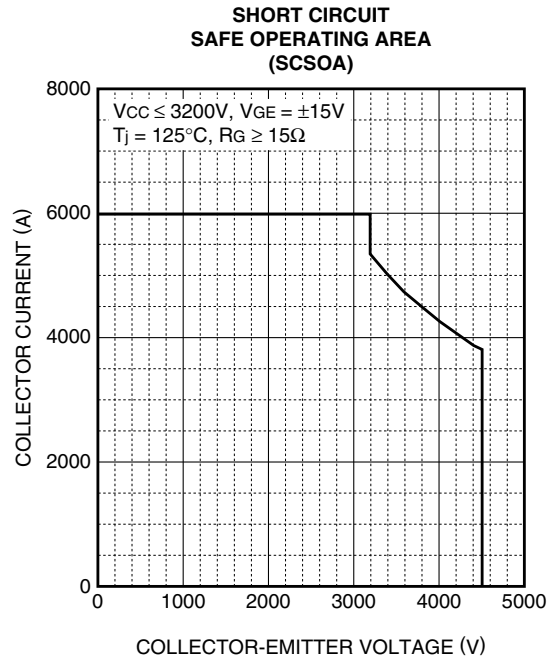
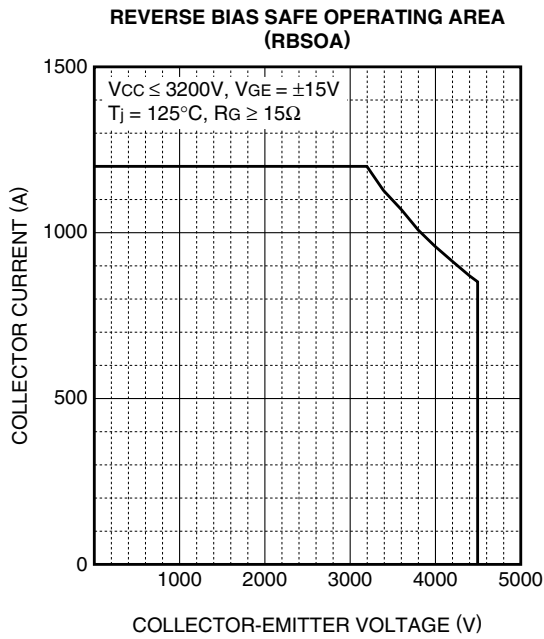

## **Important Notice**

The information contained in this datasheet shall in no event be regarded as a guarantee of conditions or characteristics. This product has to be used within its specified maximum ratings, and is subject to customer's compliance with any applicable legal requirement, norms and standards.

Except as otherwise explicitly approved by Mitsubishi Electric Corporation in a written document signed by authorized representatives of Mitsubishi Electric Corporation, our products may not be used in any applications where a failure of the product or any consequences of the use thereof can reasonably be expected to result in personal injury.

In usage of power semiconductor, there is always the possibility that trouble may occur with them by the reliability lifetime such as Power Cycle, Thermal Cycle or others, or when used under special circumstances (e.g. condensation, high humidity, dusty, salty, highlands, environment with lots of organic matter / corrosive gas / explosive gas, or situations which terminals of semiconductor products receive strong mechanical stress). Therefore, please pay sufficient attention to such circumstances. Further, depending on the technical requirements, our semiconductor products may contain environmental regulation substances, etc. If there is necessity of detailed confirmation, please contact our nearest sales branch or distributor.

The contents or data contained in this datasheet are exclusively intended for technically trained staff. Customer's technical departments should take responsibility to evaluate the suitability of Mitsubishi Electric Corporation product for the intended application and the completeness of the product data with respect to such application. In the customer's research and development, please evaluate it not only with a single semiconductor product but also in the entire system, and judge whether it's applicable. As required, pay close attention to the safety design by installing appropriate fuse or circuit breaker between a power supply and semiconductor products to prevent secondary damage. Please also pay attention to the application note and the related technical information.



## **Keep safety first in your circuit designs!**

Mitsubishi Electric Corporation puts the maximum effort into making semiconductor products better and more reliable, but there is always the possibility that trouble may occur with them. Trouble with semiconductors may lead to personal injury, fire or property damage. Remember to give due consideration to safety when making your circuit designs, with appropriate measures such as (i) placement of substitutive, auxiliary circuits, (ii) use of non-flammable material or (iii) prevention against any malfunction or mishap.

## **Notes regarding these materials**

- These materials are intended as a reference to assist our customers in the selection of the Mitsubishi Electric Semiconductor product best suited to the customer's application; they do not convey any license under any intellectual property rights, or any other rights, belonging to Mitsubishi Electric Corporation or a third party.
- Mitsubishi Electric Corporation assumes no responsibility for any damage, or infringement of any third-party's rights, originating in the use of any product data, diagrams, charts, programs, algorithms, or circuit application examples contained in these materials.
- All information contained in these materials, including product data, diagrams, charts, programs and algorithms represents information on products at the time of publication of these materials, and are subject to change by Mitsubishi Electric Corporation without notice due to product improvements or other reasons. It is therefore recommended that customers contact Mitsubishi Electric Corporation or an authorized Mitsubishi Electric Semiconductor product distributor for the latest product information before purchasing a product listed herein.  
The information described here may contain technical inaccuracies or typographical errors. Mitsubishi Electric Corporation assumes no responsibility for any damage, liability, or other loss rising from these inaccuracies or errors.  
Please also pay attention to information published by Mitsubishi Electric Corporation by various means, including the Mitsubishi Electric Semiconductor home page (<https://www.MitsubishiElectric.com/semiconductors/>).
- When using any or all of the information contained in these materials, including product data, diagrams, charts, programs, and algorithms, please be sure to evaluate all information as a total system before making a final decision on the applicability of the information and products. Mitsubishi Electric Corporation assumes no responsibility for any damage, liability or other loss resulting from the information contained herein.
- Mitsubishi Electric Corporation semiconductors are not designed or manufactured for use in a device or system that is used under circumstances in which human life is potentially at stake. Please contact Mitsubishi Electric Corporation or an authorized Mitsubishi Electric Semiconductor product distributor when considering the use of a product contained herein for any specific purposes, such as apparatus or systems for transportation, vehicular, medical, aerospace, nuclear, or undersea repeater use.
- The prior written approval of Mitsubishi Electric Corporation is necessary to reprint or reproduce in whole or in part these materials.
- If these products or technologies are subject to the Japanese export control restrictions, they must be exported under a license from the Japanese government and cannot be imported into a country other than the approved destination.  
Any diversion or re-export contrary to the export control laws and regulations of Japan and/or the country of destination is prohibited.
- Please contact Mitsubishi Electric Corporation or an authorized Mitsubishi Electric Semiconductor product distributor for further details on these materials or the products contained therein.