



Thyristor Module

$V_{RRM} = 2 \times 1600 \text{ V}$

$I_{TAV} = 49 \text{ A}$

$V_T = 1.34 \text{ V}$

Phase leg

Part number

MCC44-16io1B



Backside: isolated



Features / Advantages:

- Thyristor for line frequency
- Planar passivated chip
- Long-term stability
- Direct Copper Bonded Al₂O₃-ceramic

Applications:

- Line rectifying 50/60 Hz
- Softstart AC motor control
- DC Motor control
- Power converter
- AC power control
- Lighting and temperature control

Package: TO-240AA

- Isolation Voltage: 4800 V~
- Industry standard outline
- RoHS compliant
- Soldering pins for PCB mounting
- Base plate: DCB ceramic
- Reduced weight
- Advanced power cycling

Disclaimer Notice

Information furnished is believed to be accurate and reliable. However, users should independently evaluate the suitability of and test each product selected for their own applications. Littelfuse products are not designed for, and may not be used in, all applications. Read complete Disclaimer Notice at www.littelfuse.com/disclaimer-electronics.

Thyristor			Ratings			
Symbol	Definition	Conditions	min.	typ.	max.	Unit
$V_{RSM/DSM}$	max. non-repetitive reverse/forward blocking voltage	$T_{VJ} = 25^{\circ}C$			1700	V
$V_{RRM/DRM}$	max. repetitive reverse/forward blocking voltage	$T_{VJ} = 25^{\circ}C$			1600	V
I_{RD}	reverse current, drain current	$V_{R/D} = 1600 V$	$T_{VJ} = 25^{\circ}C$		100	μA
		$V_{R/D} = 1600 V$	$T_{VJ} = 125^{\circ}C$		5	mA
V_T	forward voltage drop	$I_T = 100 A$	$T_{VJ} = 25^{\circ}C$		1.34	V
		$I_T = 200 A$			1.75	V
		$I_T = 100 A$	$T_{VJ} = 125^{\circ}C$		1.34	V
		$I_T = 200 A$			1.80	V
I_{TAV}	average forward current	$T_C = 85^{\circ}C$	$T_{VJ} = 125^{\circ}C$		49	A
$I_{T(RMS)}$	RMS forward current	180° sine			77	A
V_{T0}	threshold voltage	} for power loss calculation only	$T_{VJ} = 125^{\circ}C$		0.85	V
r_T	slope resistance				5.3	m Ω
R_{thJC}	thermal resistance junction to case				0.53	K/W
R_{thCH}	thermal resistance case to heatsink			0.2		K/W
P_{tot}	total power dissipation		$T_C = 25^{\circ}C$		180	W
I_{TSM}	max. forward surge current	$t = 10 ms; (50 Hz), sine$	$T_{VJ} = 45^{\circ}C$		1.15	kA
		$t = 8,3 ms; (60 Hz), sine$	$V_R = 0 V$		1.24	kA
		$t = 10 ms; (50 Hz), sine$	$T_{VJ} = 125^{\circ}C$		980	A
		$t = 8,3 ms; (60 Hz), sine$	$V_R = 0 V$		1.06	kA
I^2t	value for fusing	$t = 10 ms; (50 Hz), sine$	$T_{VJ} = 45^{\circ}C$		6.62	kA ² s
		$t = 8,3 ms; (60 Hz), sine$	$V_R = 0 V$		6.40	kA ² s
		$t = 10 ms; (50 Hz), sine$	$T_{VJ} = 125^{\circ}C$		4.80	kA ² s
		$t = 8,3 ms; (60 Hz), sine$	$V_R = 0 V$		4.63	kA ² s
C_J	junction capacitance	$V_R = 400 V f = 1 MHz$	$T_{VJ} = 25^{\circ}C$		54	pF
P_{GM}	max. gate power dissipation	$t_p = 30 \mu s$	$T_C = 125^{\circ}C$		10	W
		$t_p = 300 \mu s$			5	W
P_{GAV}	average gate power dissipation				0.5	W
$(di/dt)_{cr}$	critical rate of rise of current	$T_{VJ} = 125^{\circ}C; f = 50 Hz$ repetitive, $I_T = 150 A$			150	A/ μs
		$t_p = 200 \mu s; di_G/dt = 0.45 A/\mu s;$ $I_G = 0.45 A; V = \frac{2}{3} V_{DRM}$ non-repet., $I_T = 49 A$			500	A/ μs
$(dv/dt)_{cr}$	critical rate of rise of voltage	$V = \frac{2}{3} V_{DRM}$ $R_{GK} = \infty; \text{method 1 (linear voltage rise)}$	$T_{VJ} = 125^{\circ}C$		1000	V/ μs
V_{GT}	gate trigger voltage	$V_D = 6 V$	$T_{VJ} = 25^{\circ}C$		1.5	V
			$T_{VJ} = -40^{\circ}C$		1.6	V
I_{GT}	gate trigger current	$V_D = 6 V$	$T_{VJ} = 25^{\circ}C$		100	mA
			$T_{VJ} = -40^{\circ}C$		200	mA
V_{GD}	gate non-trigger voltage	$V_D = \frac{2}{3} V_{DRM}$	$T_{VJ} = 125^{\circ}C$		0.2	V
I_{GD}	gate non-trigger current				10	mA
I_L	latching current	$t_p = 10 \mu s$	$T_{VJ} = 25^{\circ}C$		450	mA
		$I_G = 0.45 A; di_G/dt = 0.45 A/\mu s$				
I_H	holding current	$V_D = 6 V R_{GK} = \infty$	$T_{VJ} = 25^{\circ}C$		200	mA
t_{gd}	gate controlled delay time	$V_D = \frac{1}{2} V_{DRM}$ $I_G = 0.45 A; di_G/dt = 0.45 A/\mu s$	$T_{VJ} = 25^{\circ}C$		2	μs
t_q	turn-off time	$V_R = 100 V; I_T = 120 A; V = \frac{2}{3} V_{DRM}$ $di/dt = 10 A/\mu s dv/dt = 20 V/\mu s t_p = 200 \mu s$	$T_{VJ} = 100^{\circ}C$		150	μs



Package TO-240AA				Ratings			
Symbol	Definition	Conditions	min.	typ.	max.	Unit	
I_{RMS}	RMS current	per terminal			200	A	
T_{VJ}	virtual junction temperature		-40		125	°C	
T_{op}	operation temperature		-40		100	°C	
T_{stg}	storage temperature		-40		125	°C	
Weight					81	g	
M_D	mounting torque		2.5		4	Nm	
M_T	terminal torque		2.5		4	Nm	
$d_{Spp/App}$	creepage distance on surface striking distance through air	terminal to terminal	13.0	9.7		mm	
$d_{Spb/Apb}$		terminal to backside	16.0	16.0		mm	
V_{ISOL}	isolation voltage	t = 1 second		4800		V	
		t = 1 minute	50/60 Hz, RMS; $I_{ISOL} \leq 1$ mA	4000		V	

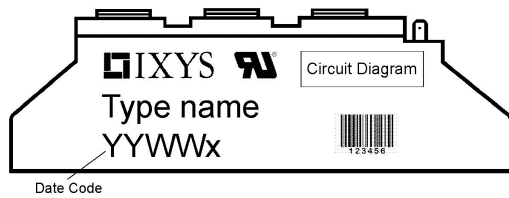

Ordering	Ordering Number	Marking on Product	Delivery Mode	Quantity	Code No.
Standard	MCC44-16io1B	MCC44-16io1B	Box	36	452920

Similar Part	Package	Voltage class
MCMA50P1600TA	TO-240AA-1B	1600
MCMA65P1600TA	TO-240AA-1B	1600

Equivalent Circuits for Simulation

* on die level

$T_{VJ} = 125^{\circ}C$

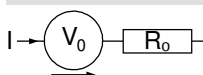

Thyristor

$V_{0\ max}$	threshold voltage	0.85	V
$R_{0\ max}$	slope resistance *	4.1	mΩ



Outlines TO-240AA



General tolerance: DIN ISO 2768 class „c“

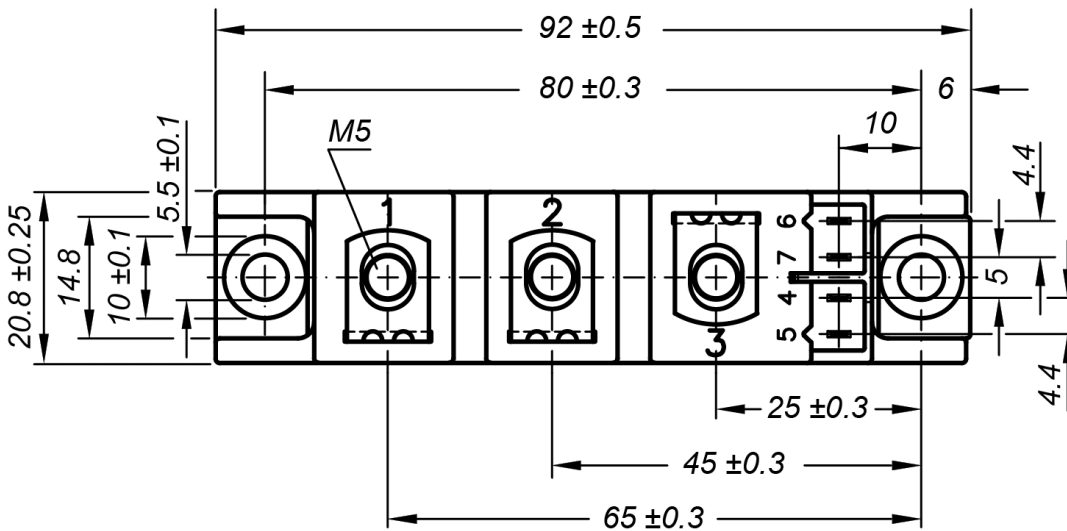

Optional accessories for modules

Keyed gate/cathode twin plugs with wire length = 350 mm, gate = white, cathode = red

Type ZY 200L (L = Left for pin pair 4/5) } UL 758, style 3751
 Type ZY 200R (R = Right for pin pair 6/7) }

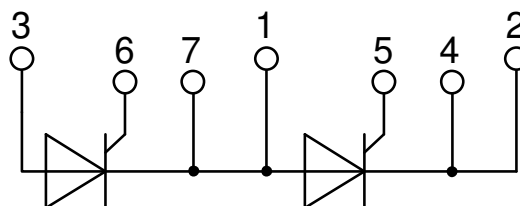

Thyristor



Fig. 1 Surge overload current
 I_{TSM} , I_{FSM} : Crest value, t: duration

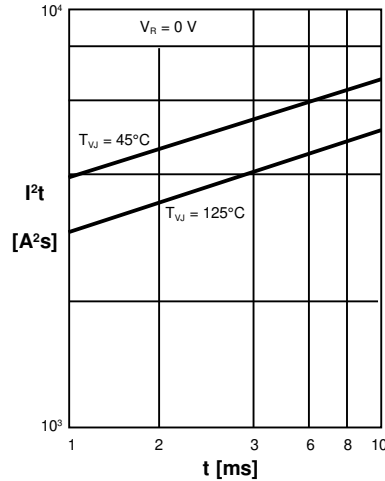

Fig. 2 I^2t versus time (1-10 ms)

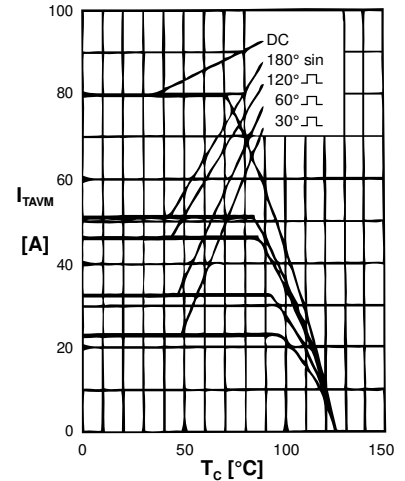

Fig. 3 Maximum forward current at case temperature



Fig. 4 Power dissipation vs. onstate current and ambient temperature (per thyristor/diode)

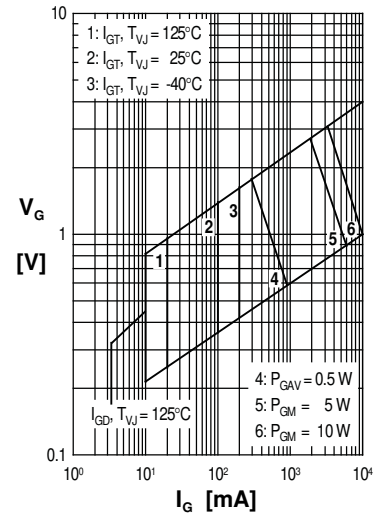

Fig. 5 Gate trigger characteristics

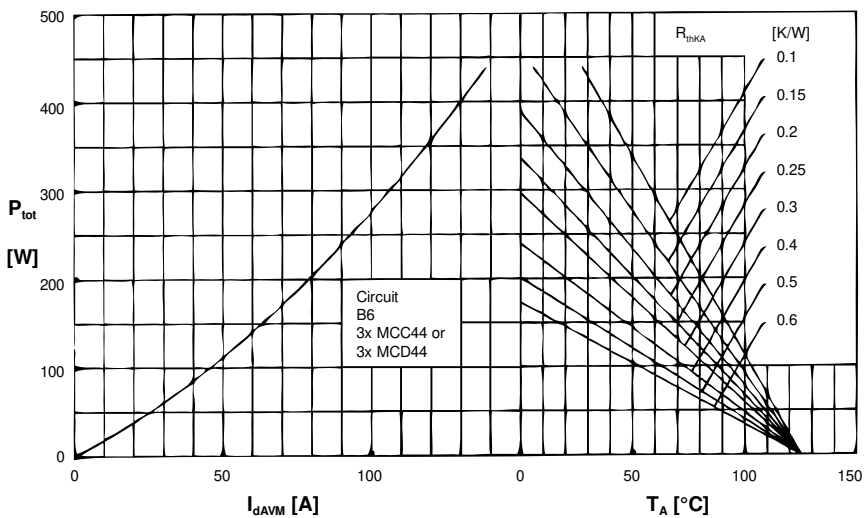

Fig. 6 Three phase rectifier bridge: Power dissipation versus direct output current and ambient temperature

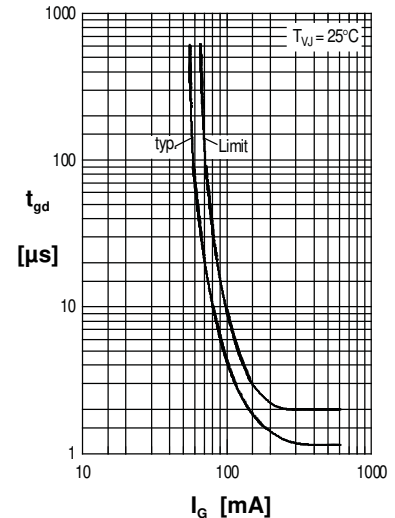

Fig. 7 Gate trigger delay time



Thyristor



Fig. 8 Three phase AC-controller: Power dissipation versus RMS output current and ambient temperature



Fig. 9 Transient thermal impedance junction to case (per thyristor)

R_{thJC} for various conduction angles d:

d	R_{thJC} [KW]
DC	0.53
180°	0.55
120°	0.58
60°	0.60
30°	0.62

Constants for Z_{thJC} calculation:

i	R_{thi} [KW]	t_i [s]
1	0.015	0.0035
2	0.026	0.0200
3	0.489	0.1950

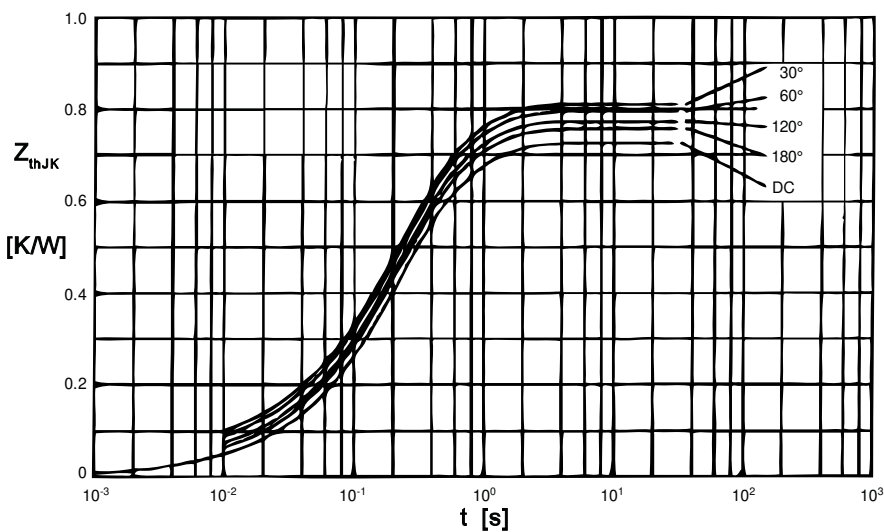

Fig. 10 Transient thermal impedance junction to heatsink (per thyristor)

R_{thJK} for various conduction angles d:

d	R_{thJK} [KW]
DC	0.73
180°	0.75
120°	0.78
60°	0.80
30°	0.82

Constants for Z_{thJK} calculation:

i	R_{thi} [KW]	t_i [s]
1	0.015	0.0035
2	0.026	0.0200
3	0.489	0.0195
4	0.200	0.6800