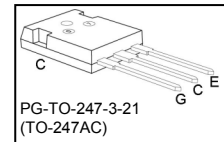
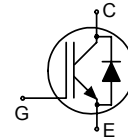


## Fast IGBT in NPT-technology with soft, fast recovery anti-parallel EmCon diode

- 40% lower  $E_{off}$  compared to previous generation
- Short circuit withstand time – 10  $\mu$ s
- Designed for:
  - Motor controls
  - Inverter
  - SMPS
- NPT-Technology offers:
  - very tight parameter distribution
  - high ruggedness, temperature stable behaviour
  - parallel switching capability
- Pb-free lead plating; RoHS compliant
- Qualified according to JEDEC<sup>1</sup> for target applications
- Complete product spectrum and PSpice Models : <http://www.infineon.com/igbt/>



Type	$V_{CE}$	$I_C$	$E_{off}$	$T_j$	Marking	Package
SKW25N120	1200V	25A	2.9mJ	150°C	K25N120	PG-TO-247-3-21

### Maximum Ratings

Parameter	Symbol	Value	Unit
Collector-emitter voltage	$V_{CE}$	1200	V
DC collector current	$I_C$	46	A
$T_C = 25^\circ\text{C}$		25	
$T_C = 100^\circ\text{C}$			
Pulsed collector current, $t_p$ limited by $T_{jmax}$	$I_{Cpuls}$	84	
Turn off safe operating area	-	84	
$V_{CE} \leq 1200\text{V}, T_j \leq 150^\circ\text{C}$			
Diode forward current	$I_F$	42	
$T_C = 25^\circ\text{C}$		25	
$T_C = 100^\circ\text{C}$			
Diode pulsed current, $t_p$ limited by $T_{jmax}$	$I_{Fpuls}$	80	
Gate-emitter voltage	$V_{GE}$	$\pm 20$	V
Short circuit withstand time <sup>2</sup>	$t_{SC}$	10	$\mu$ s
$V_{GE} = 15\text{V}, 100\text{V} \leq V_{CC} \leq 1200\text{V}, T_j \leq 150^\circ\text{C}$			
Power dissipation	$P_{tot}$	313	W
$T_C = 25^\circ\text{C}$			
Operating junction and storage temperature	$T_j, T_{stg}$	-55...+150	$^\circ\text{C}$
Soldering temperature, wavesoldering, 1.6mm (0.063 in.) from case for 10s	$T_s$	260	

<sup>1</sup> J-STD-020 and JESD-022

<sup>2</sup> Allowed number of short circuits: <1000; time between short circuits: >1s.

**Thermal Resistance**

Parameter	Symbol	Conditions	Max. Value	Unit
<b>Characteristic</b>				
IGBT thermal resistance, junction – case	$R_{thJC}$		0.4	K/W
Diode thermal resistance, junction – case	$R_{thJCD}$		1.15	
Thermal resistance, junction – ambient	$R_{thJA}$		40	

**Electrical Characteristic, at  $T_j = 25^\circ\text{C}$ , unless otherwise specified**

Parameter	Symbol	Conditions	Value			Unit
			min.	typ.	max.	
<b>Static Characteristic</b>						
Collector-emitter breakdown voltage	$V_{(BR)CES}$	$V_{GE}=0V, I_C=1500\mu A$	1200	-	-	V
Collector-emitter saturation voltage	$V_{CE(sat)}$	$V_{GE} = 15V, I_C=25A$ $T_j=25^\circ\text{C}$ $T_j=150^\circ\text{C}$	2.5 -	3.1 3.7	3.6 4.3	
Diode forward voltage	$V_F$	$V_{GE}=0V, I_F=25A$ $T_j=25^\circ\text{C}$ $T_j=150^\circ\text{C}$	-	2.0 1.75	2.5	
Gate-emitter threshold voltage	$V_{GE(th)}$	$I_C=1000\mu A, V_{CE}=V_{GE}$	3	4	5	
Zero gate voltage collector current	$I_{CES}$	$V_{CE}=1200V, V_{GE}=0V$ $T_j=25^\circ\text{C}$ $T_j=150^\circ\text{C}$	- -	- -	350 1400	$\mu A$
Gate-emitter leakage current	$I_{GES}$	$V_{CE}=0V, V_{GE}=20V$	-	-	100	nA
Transconductance	$g_{fs}$	$V_{CE}=20V, I_C=25A$		20	-	S
<b>Dynamic Characteristic</b>						
Input capacitance	$C_{iss}$	$V_{CE}=25V, V_{GE}=0V, f=1\text{MHz}$	-	2150	2600	pF
Output capacitance	$C_{oss}$		-	260	310	
Reverse transfer capacitance	$C_{rss}$		-	110	130	
Gate charge	$Q_{Gate}$	$V_{CC}=960V, I_C=25A, V_{GE}=15V$	-	225	300	nC
Internal emitter inductance Measured 5mm (0.197 in.) from case	$L_E$		-	13	-	nH
Short circuit collector current <sup>1)</sup>	$I_{C(SC)}$	$V_{GE}=15V, t_{SC}\leq 10\mu s$ $100V\leq V_{CC}\leq 1200V, T_j\leq 150^\circ\text{C}$	-	240	-	A

<sup>1)</sup> Allowed number of short circuits: <1000; time between short circuits: >1s

**Switching Characteristic, Inductive Load, at  $T_j=25\text{ }^\circ\text{C}$** 

Parameter	Symbol	Conditions	Value			Unit
			Min.	typ.	max.	
<b>IGBT Characteristic</b>						
Turn-on delay time	$t_{d(on)}$	$T_j=25\text{ }^\circ\text{C}$ , $V_{CC}=800\text{V}$ , $I_C=25\text{A}$ , $V_{GE}=15/0\text{V}$ , $R_G=22\Omega$ , $L_\sigma^{(1)}=180\text{nH}$ , $C_\sigma^{(1)}=40\text{pF}$ Energy losses include "tail" and diode reverse recovery.	-	45	60	ns
Rise time	$t_r$		-	40	52	
Turn-off delay time	$t_{d(off)}$		-	730	950	
Fall time	$t_f$		-	30	39	
Turn-on energy	$E_{on}$		-	2.2	2.9	mJ
Turn-off energy	$E_{off}$		-	1.5	2.0	
Total switching energy	$E_{ts}$		-	3.7	4.9	

**Anti-Parallel Diode Characteristic**

Diode reverse recovery time	$t_{rr}$	$T_j=25\text{ }^\circ\text{C}$ , $V_R=800\text{V}$ , $I_F=25\text{A}$ , $di_F/dt=650\text{A}/\mu\text{s}$	-	90		ns
	$t_S$		-			
	$t_F$		-			
Diode reverse recovery charge	$Q_{rr}$		-	1.0		$\mu\text{C}$
Diode peak reverse recovery current	$I_{rrm}$		-	20		A
Diode peak rate of fall of reverse recovery current during $t_F$	$di_{rr}/dt$	-	470		$\text{A}/\mu\text{s}$	

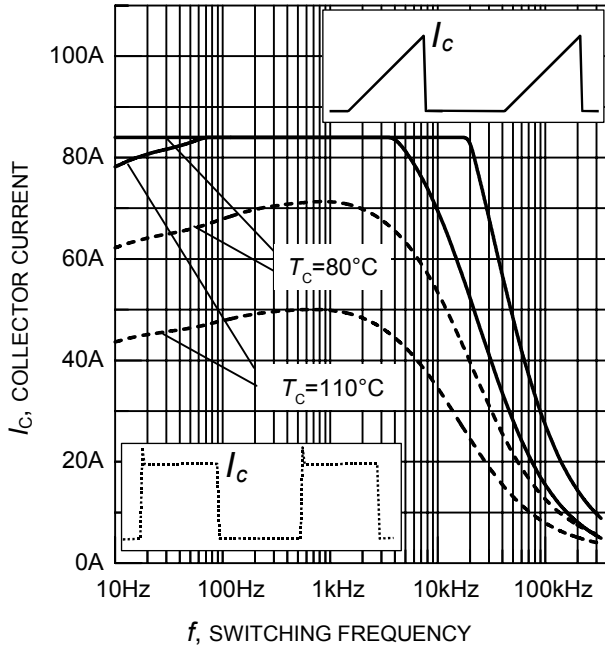
**Switching Characteristic, Inductive Load, at  $T_j=150\text{ }^\circ\text{C}$** 

Parameter	Symbol	Conditions	Value			Unit
			Min.	typ.	max.	
<b>IGBT Characteristic</b>						
Turn-on delay time	$t_{d(on)}$	$T_j=150\text{ }^\circ\text{C}$ $V_{CC}=800\text{V}$ , $I_C=25\text{A}$ , $V_{GE}=15/0\text{V}$ , $R_G=22\Omega$ , $L_\sigma^{(1)}=180\text{nH}$ , $C_\sigma^{(1)}=40\text{pF}$ Energy losses include "tail" and diode reverse recovery.	-	50	60	ns
Rise time	$t_r$		-	36	43	
Turn-off delay time	$t_{d(off)}$		-	820	990	
Fall time	$t_f$		-	42	50	
Turn-on energy	$E_{on}$		-	3.8	4.6	mJ
Turn-off energy	$E_{off}$		-	2.9	3.8	
Total switching energy	$E_{ts}$		-	6.7	8.4	

**Anti-Parallel Diode Characteristic**

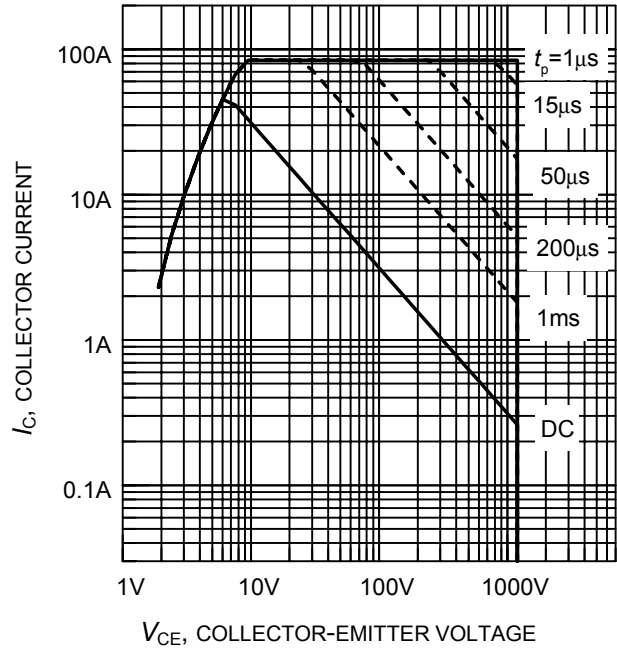
Diode reverse recovery time	$t_{rr}$	$T_j=150\text{ }^\circ\text{C}$ $V_R=800\text{V}$ , $I_F=25\text{A}$ , $di_F/dt=750\text{A}/\mu\text{s}$	-	280		ns
	$t_S$		-			
	$t_F$		-			
Diode reverse recovery charge	$Q_{rr}$		-	4.3		$\mu\text{C}$
Diode peak reverse recovery current	$I_{rrm}$		-	32		A
Diode peak rate of fall of reverse recovery current during $t_F$	$di_{rr}/dt$	-	130		$\text{A}/\mu\text{s}$	

<sup>1)</sup> Leakage inductance  $L_\sigma$  and stray capacity  $C_\sigma$  due to dynamic test circuit in figure E.



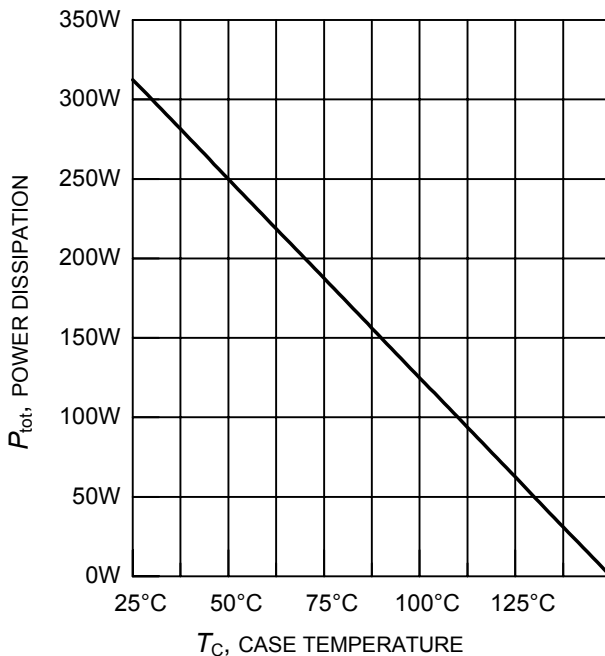
**Figure 1. Collector current as a function of switching frequency**

( $T_j \leq 150^\circ\text{C}$ ,  $D = 0.5$ ,  $V_{CE} = 800\text{V}$ ,  $V_{GE} = +15\text{V}/0\text{V}$ ,  $R_G = 22\Omega$ )



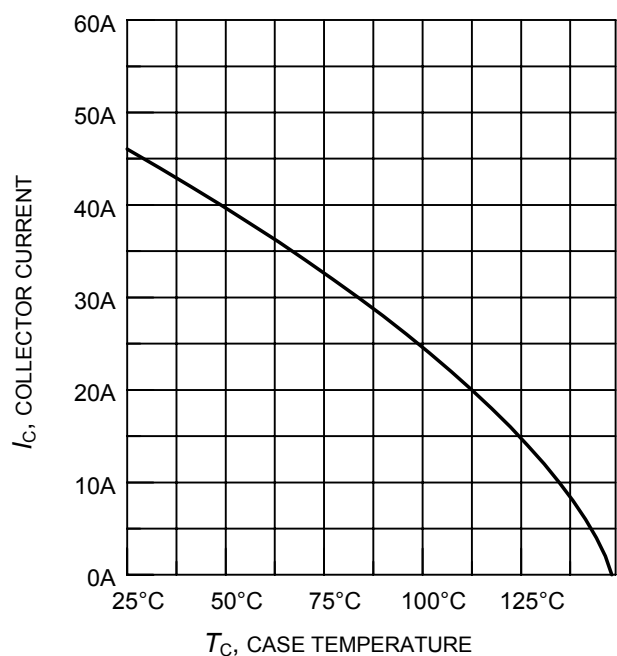
**Figure 2. Safe operating area**

( $D = 0$ ,  $T_C = 25^\circ\text{C}$ ,  $T_j \leq 150^\circ\text{C}$ )



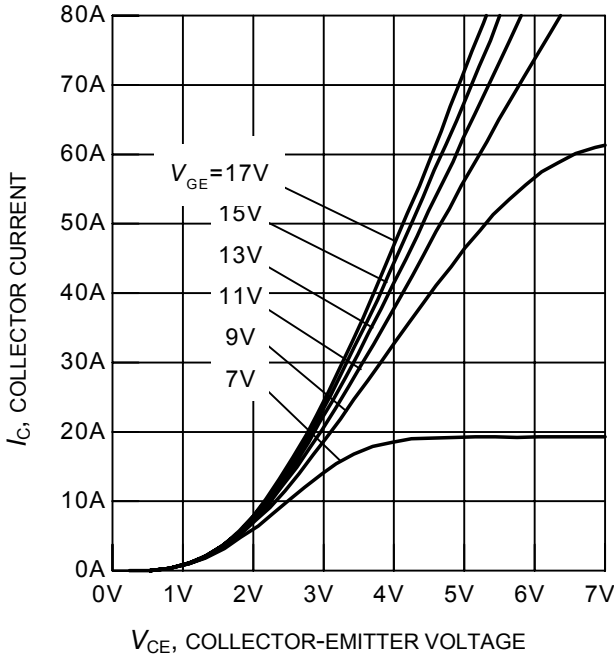
**Figure 3. Power dissipation as a function of case temperature**

( $T_j \leq 150^\circ\text{C}$ )

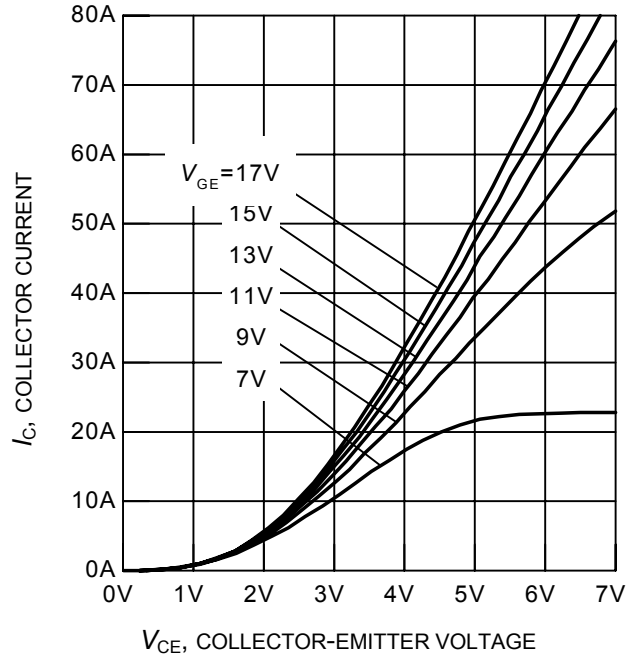


**Figure 4. Collector current as a function of case temperature**

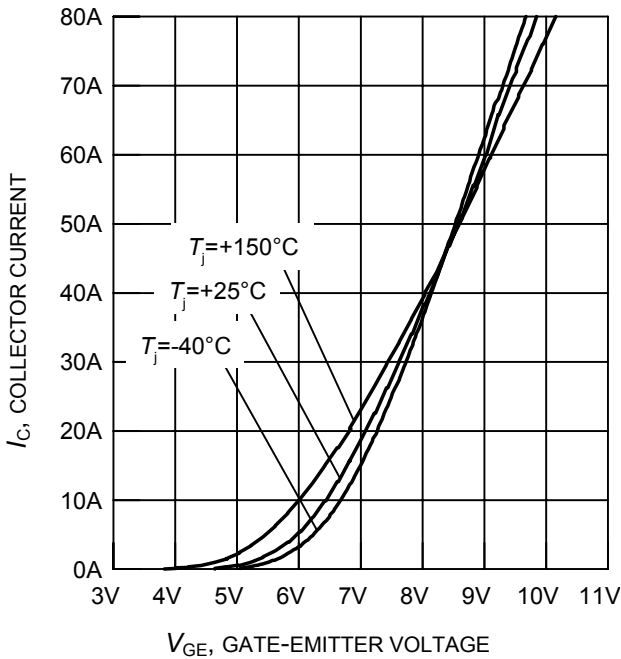
( $V_{GE} \leq 15\text{V}$ ,  $T_j \leq 150^\circ\text{C}$ )



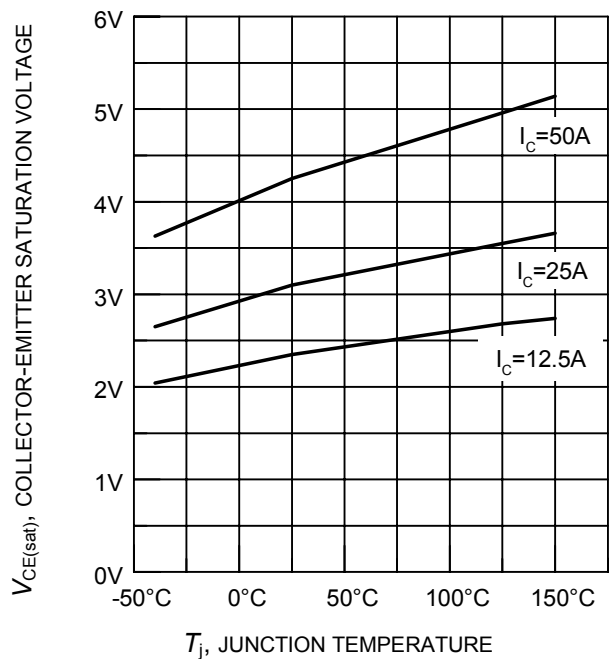
**Figure 5. Typical output characteristics**  
( $T_j = 25^\circ\text{C}$ )



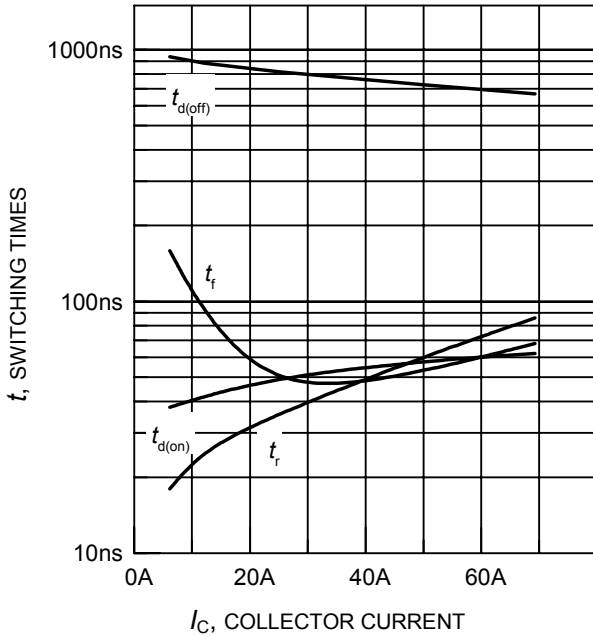
**Figure 6. Typical output characteristics**  
( $T_j = 150^\circ\text{C}$ )



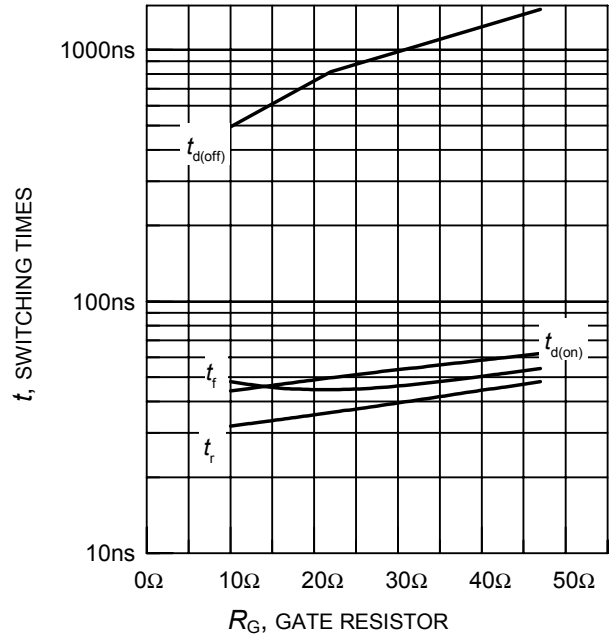
**Figure 7. Typical transfer characteristics**  
( $V_{CE} = 20\text{V}$ )



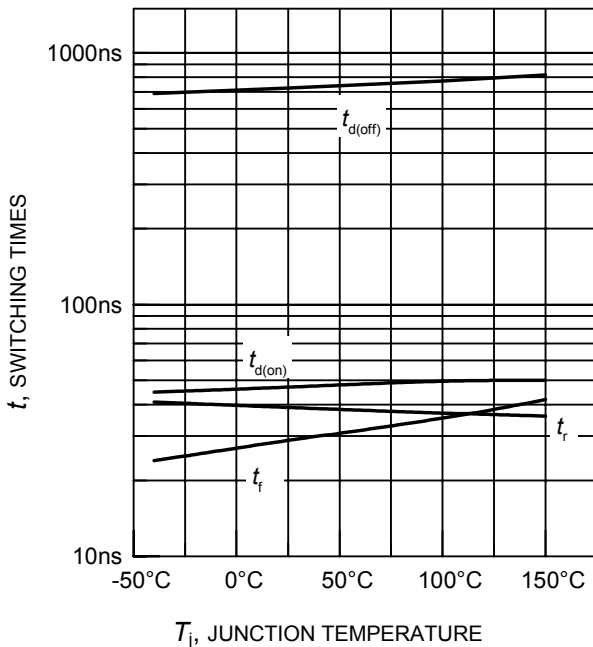
**Figure 8. Typical collector-emitter saturation voltage as a function of junction temperature**  
( $V_{GE} = 15\text{V}$ )



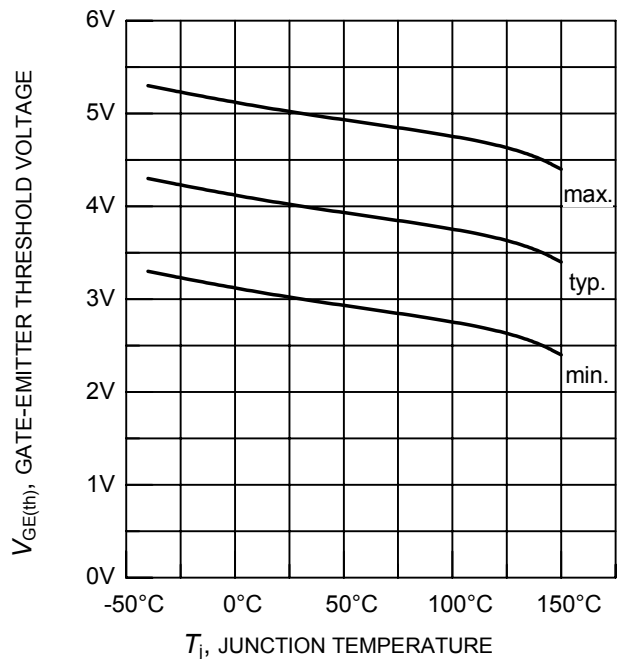
**Figure 9. Typical switching times as a function of collector current**  
 (inductive load,  $T_j = 150^\circ\text{C}$ ,  
 $V_{CE} = 800\text{V}$ ,  $V_{GE} = +15\text{V}/0\text{V}$ ,  $R_G = 22\Omega$ ,  
 dynamic test circuit in Fig.E )



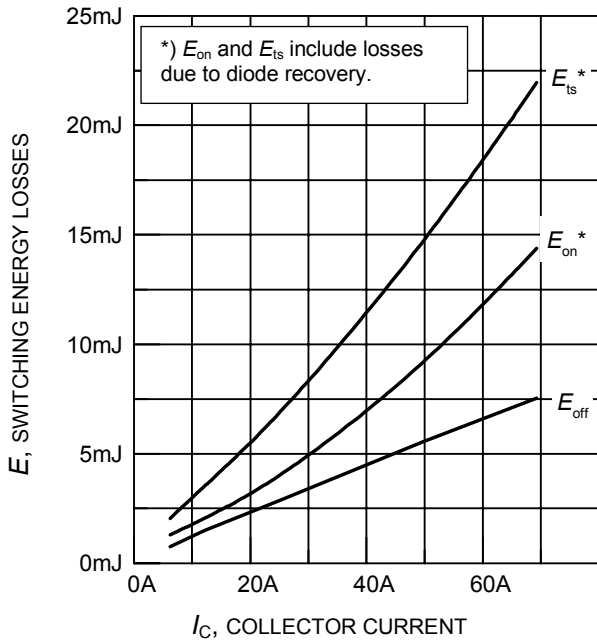
**Figure 10. Typical switching times as a function of gate resistor**  
 (inductive load,  $T_j = 150^\circ\text{C}$ ,  
 $V_{CE} = 800\text{V}$ ,  $V_{GE} = +15\text{V}/0\text{V}$ ,  $I_C = 25\text{A}$ ,  
 dynamic test circuit in Fig.E )



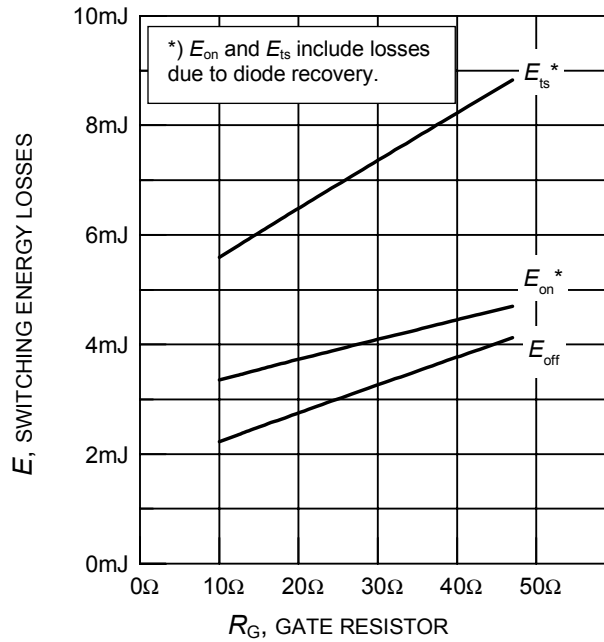
**Figure 11. Typical switching times as a function of junction temperature**  
 (inductive load,  $V_{CE} = 800\text{V}$ ,  
 $V_{GE} = +15\text{V}/0\text{V}$ ,  $I_C = 25\text{A}$ ,  $R_G = 22\Omega$ ,  
 dynamic test circuit in Fig.E )



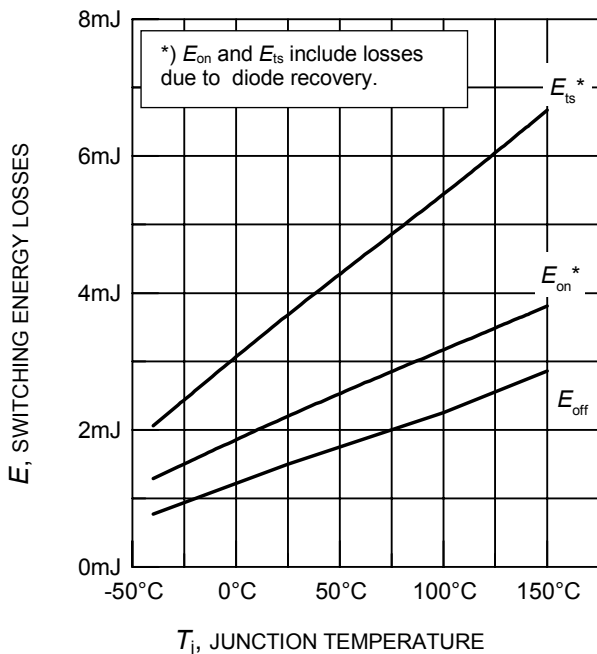
**Figure 12. Gate-emitter threshold voltage as a function of junction temperature**  
 ( $I_C = 0.3\text{mA}$ )



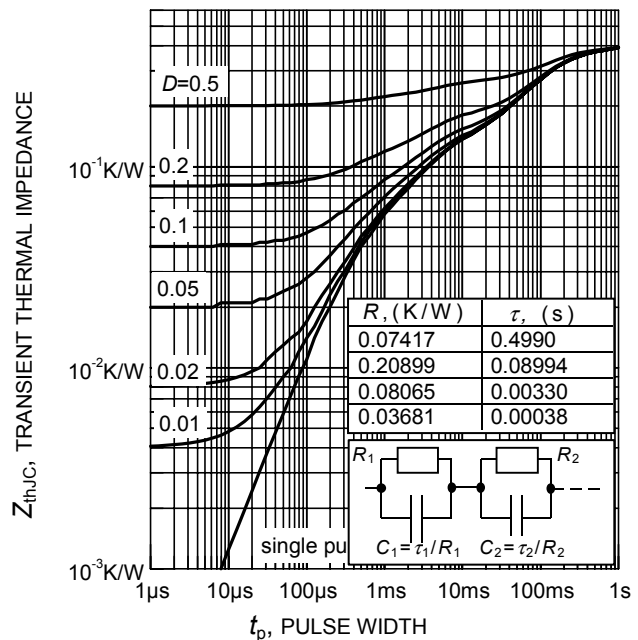
**Figure 13. Typical switching energy losses as a function of collector current**  
 (inductive load,  $T_j = 150^\circ\text{C}$ ,  $V_{CE} = 800\text{V}$ ,  $V_{GE} = +15\text{V}/0\text{V}$ ,  $R_G = 22\Omega$ , dynamic test circuit in Fig.E )



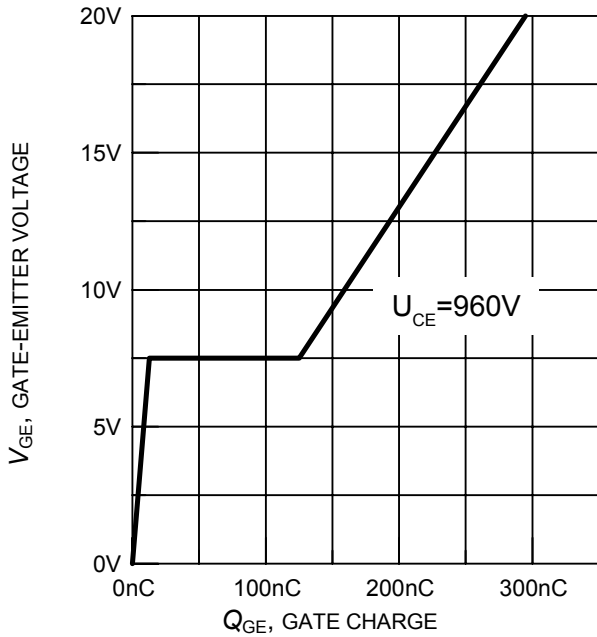
**Figure 14. Typical switching energy losses as a function of gate resistor**  
 (inductive load,  $T_j = 150^\circ\text{C}$ ,  $V_{CE} = 800\text{V}$ ,  $V_{GE} = +15\text{V}/0\text{V}$ ,  $I_C = 25\text{A}$ , dynamic test circuit in Fig.E )



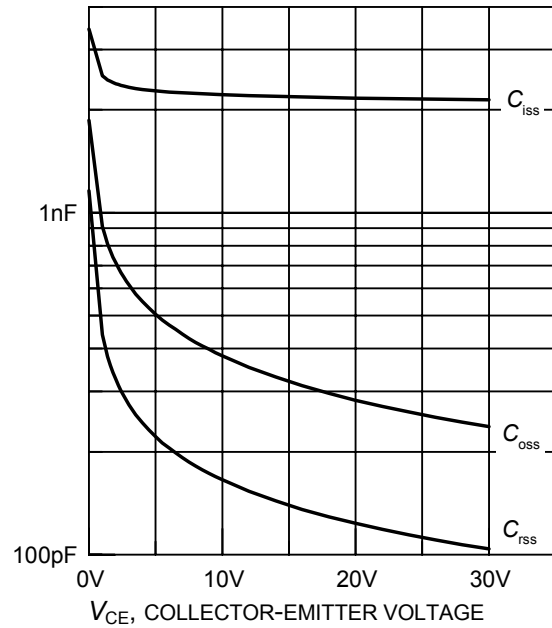
**Figure 15. Typical switching energy losses as a function of junction temperature**  
 (inductive load,  $V_{CE} = 800\text{V}$ ,  $V_{GE} = +15\text{V}/0\text{V}$ ,  $I_C = 25\text{A}$ ,  $R_G = 22\Omega$ , dynamic test circuit in Fig.E )



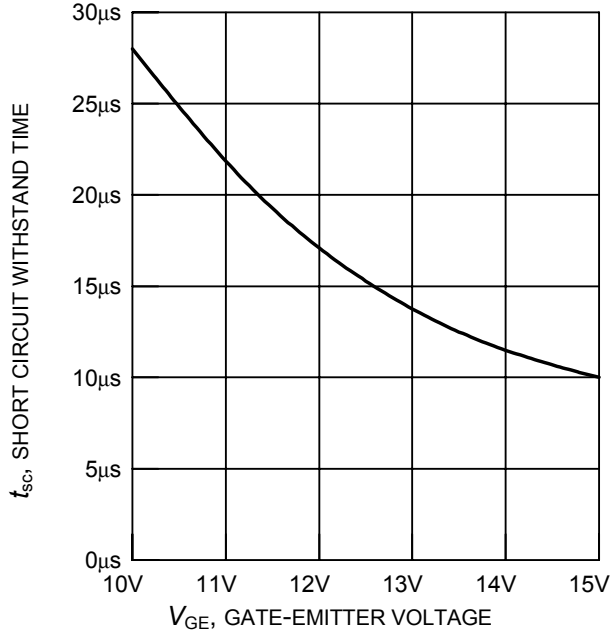
**Figure 16. IGBT transient thermal impedance as a function of pulse width**  
 ( $D = t_p / T$ )



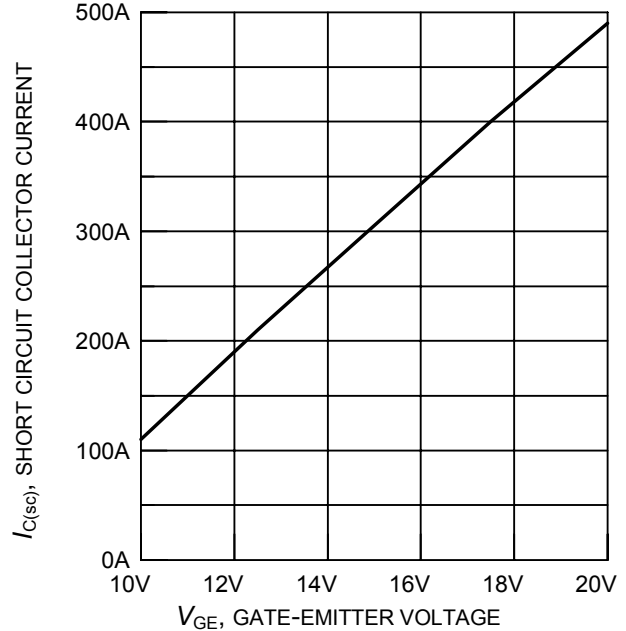
**Figure 17. Typical gate charge**  
( $I_C = 25A$ )



**Figure 18. Typical capacitance as a function of collector-emitter voltage**  
( $V_{GE} = 0V, f = 1MHz$ )

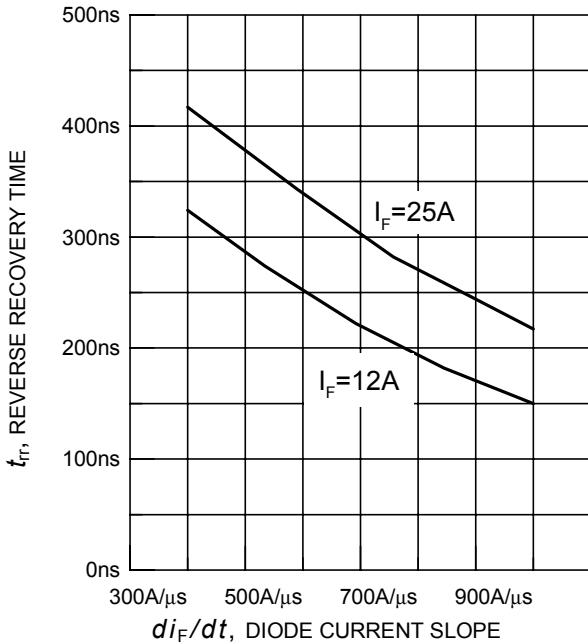


**Figure 19. Short circuit withstand time as a function of gate-emitter voltage**  
( $V_{CE} = 1200V, \text{start at } T_j = 25^\circ C$ )

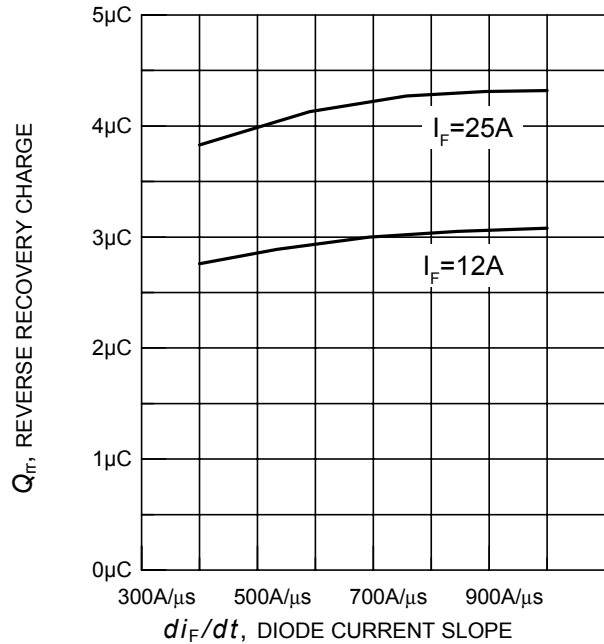


**Figure 20. Typical short circuit collector current as a function of gate-emitter voltage**  
( $100V \leq V_{CE} \leq 1200V, T_C = 25^\circ C, T_j \leq 150^\circ C$ )

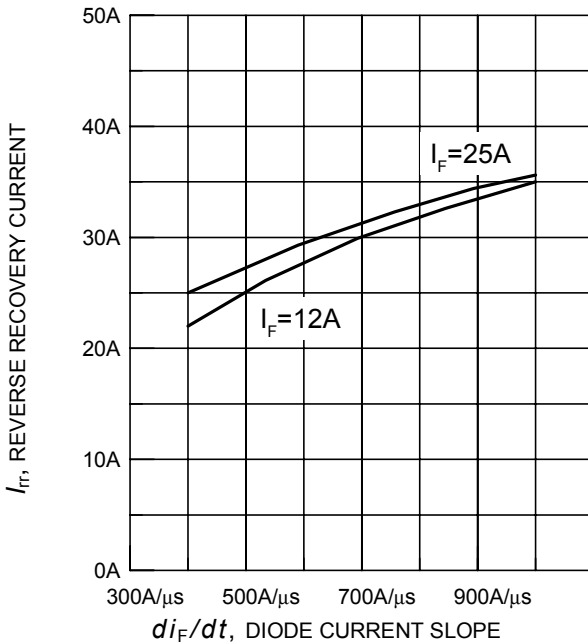




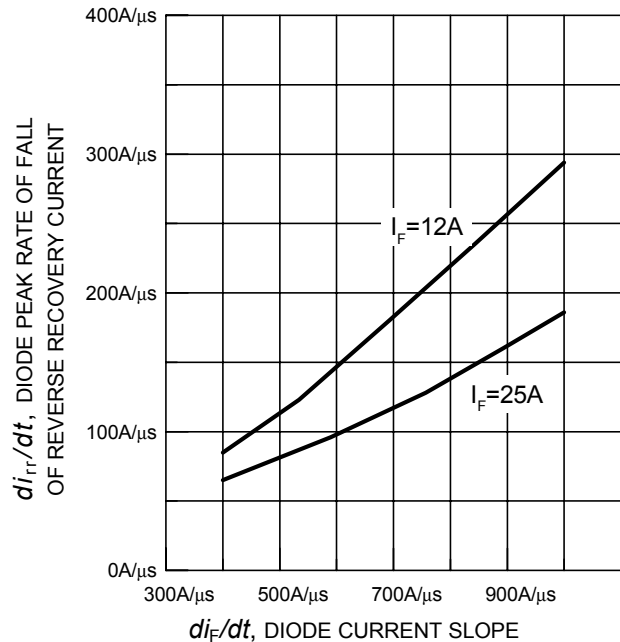
**Figure 21. Typical reverse recovery time as a function of diode current slope**  
 ( $V_R = 800V$ ,  $T_j = 150^\circ C$ , dynamic test circuit in Fig.E )



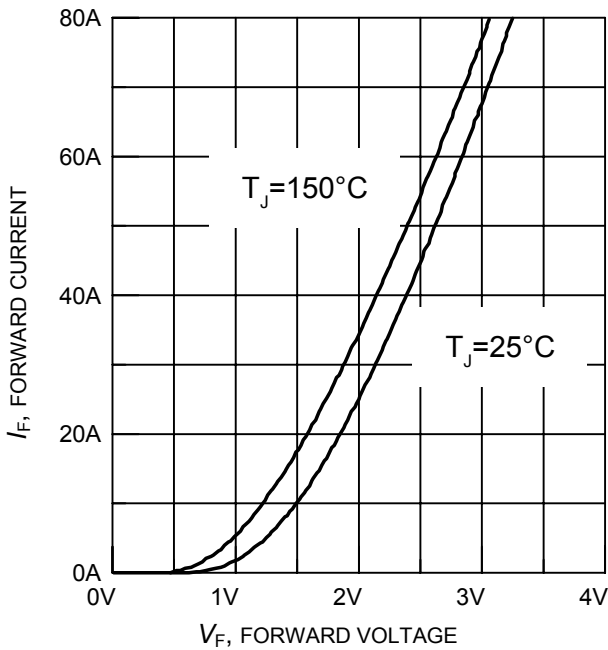
**Figure 22. Typical reverse recovery charge as a function of diode current slope**  
 ( $V_R = 800V$ ,  $T_j = 150^\circ C$ , dynamic test circuit in Fig.E )



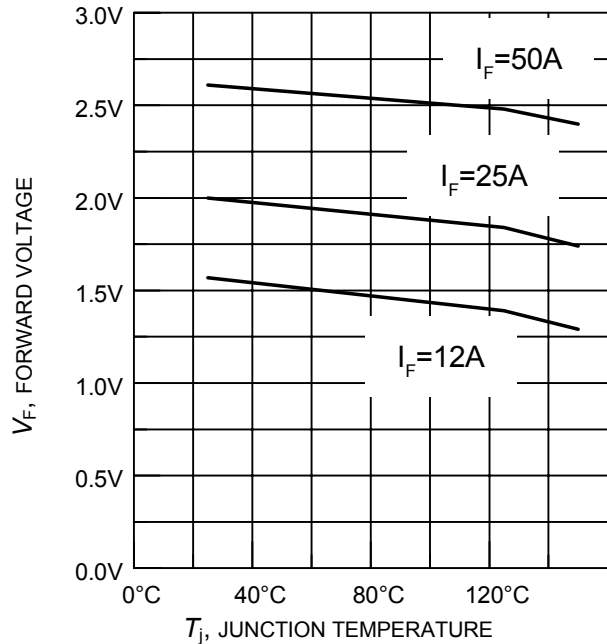
**Figure 23. Typical reverse recovery current as a function of diode current slope**  
 ( $V_R = 800V$ ,  $T_j = 150^\circ C$ , dynamic test circuit in Fig.E )



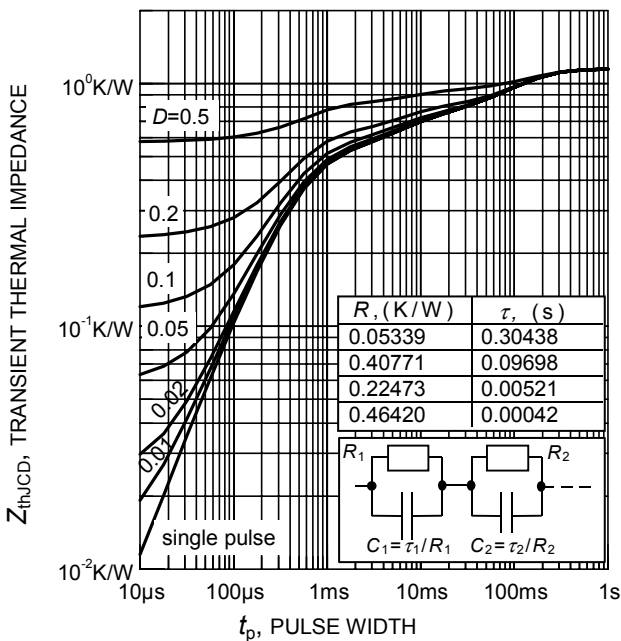
**Figure 24. Typical diode peak rate of fall of reverse recovery current as a function of diode current slope**  
 ( $V_R = 800V$ ,  $T_j = 150^\circ C$ , dynamic test circuit in Fig.E )



**Figure 25. Typical diode forward current as a function of forward voltage**

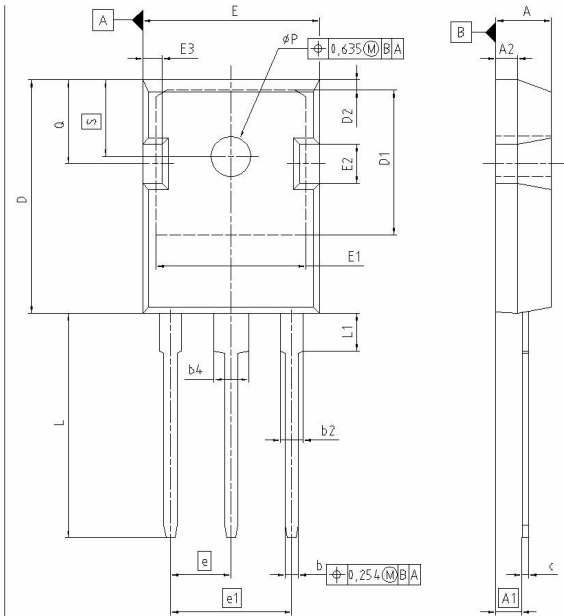


**Figure 26. Typical diode forward voltage as a function of junction temperature**

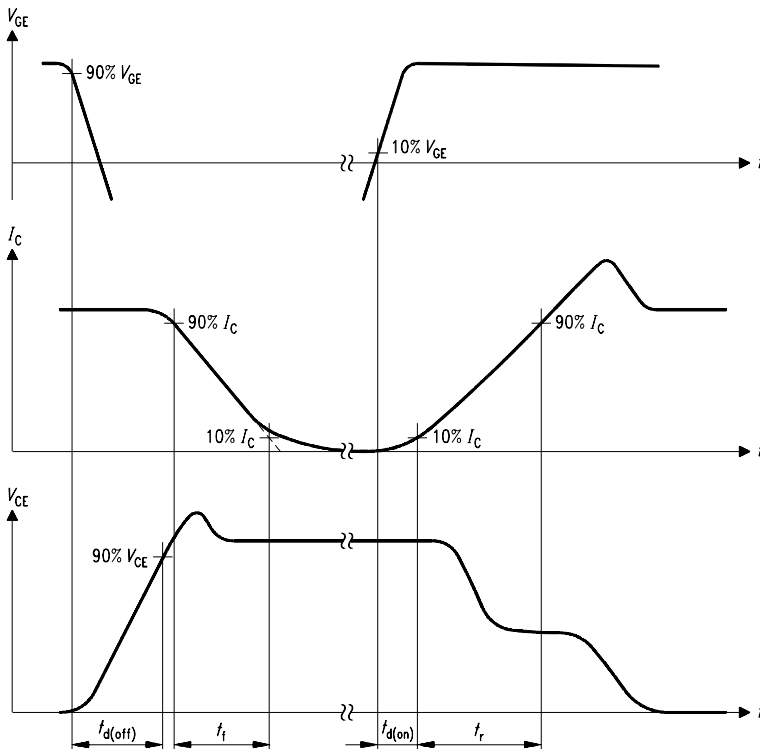


**Figure 27. Diode transient thermal impedance as a function of pulse width ( $D = t_p / T$ )**

PG-TO247-3-21

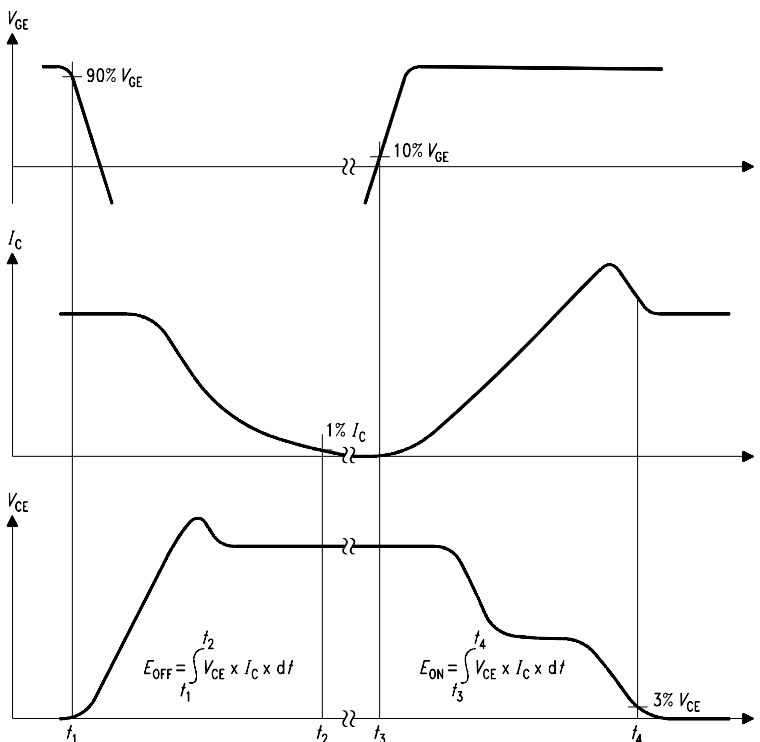


DIM	MILLIMETERS		INCHES	
	MIN	MAX	MIN	MAX
A	4.903	5.157	0.193	0.203
A1	2.273	2.527	0.092	0.096
A2	1.853	2.107	0.075	0.081
b	1.073	1.327	0.047	0.052
b2	1.903	2.386	0.075	0.094
b4	2.870	3.454	0.113	0.136
c	0.549	0.752	0.024	0.030
D	20.823	21.077	0.820	0.830
D1	17.323	17.831	0.682	0.702
D2	1.063	1.317	0.042	0.052
E	15.773	16.027	0.621	0.631
E1	13.893	14.147	0.547	0.557
E2	3.683	3.937	0.145	0.155
E3	1.683	1.937	0.066	0.076
e	5.450		0.215	
e1	10.900		0.430	
N	3		3	
L	20.053	20.307	0.789	0.799
L1	4.168	4.472	0.164	0.176
øP	3.559	3.661	0.140	0.144
Q	5.493	5.747	0.216	0.226
S	6.043	6.297	0.238	0.248



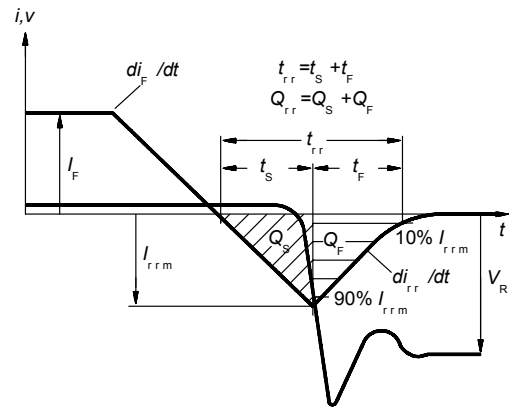
**Figure A. Definition of switching times**

SIS00053

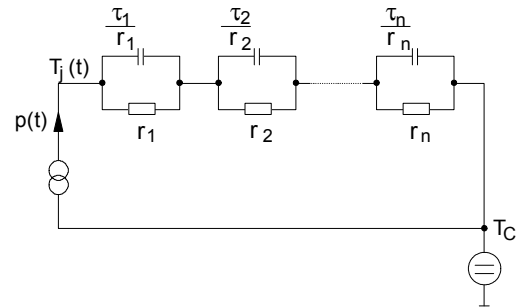


**Figure B. Definition of switching losses**

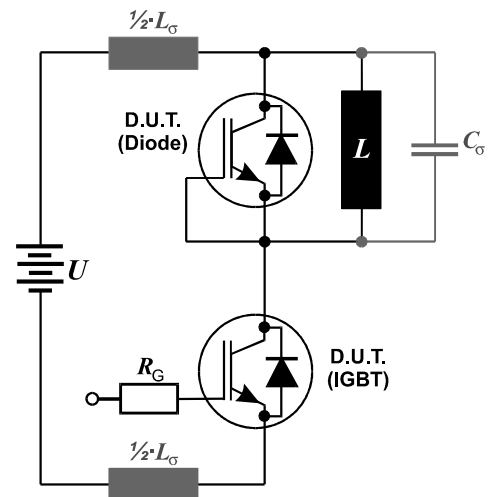
SIS00050



**Figure C. Definition of diodes switching characteristics**



**Figure D. Thermal equivalent circuit**



**Figure E. Dynamic test circuit**  
Leakage inductance  $L_{\sigma}=180\text{nH}$ ,  
and stray capacity  $C_{\sigma}=40\text{pF}$ .

**Edition 2006-01**

**Published by  
Infineon Technologies AG  
81726 München, Germany**

**© Infineon Technologies AG 11/15/06.**

**All Rights Reserved.**

**Attention please!**

The information given in this data sheet shall in no event be regarded as a guarantee of conditions or characteristics ("Beschaffenheitsgarantie"). With respect to any examples or hints given herein, any typical values stated herein and/or any information regarding the application of the device, Infineon Technologies hereby disclaims any and all warranties and liabilities of any kind, including without limitation warranties of non-infringement of intellectual property rights of any third party.

**Information**

For further information on technology, delivery terms and conditions and prices please contact your nearest Infineon Technologies Office ([www.infineon.com](http://www.infineon.com)).

**Warnings**

Due to technical requirements components may contain dangerous substances. For information on the types in question please contact your nearest Infineon Technologies Office.

Infineon Technologies Components may only be used in life-support devices or systems with the express written approval of Infineon Technologies, if a failure of such components can reasonably be expected to cause the failure of that life-support device or system, or to affect the safety or effectiveness of that device or system. Life support devices or systems are intended to be implanted in the human body, or to support and/or maintain and sustain and/or protect human life. If they fail, it is reasonable to assume that the health of the user or other persons may be endangered.