

EconoPACK™4 Modul mit schnellem Trench/Feldstopp IGBT4 und Emitter Controlled 4 Diode und PressFIT / NTC

EconoPACK™4 module with fast Trench/Fieldstop IGBT4 and Emitter Controlled 4 diode and PressFIT / NTC

Vorläufige Daten / Preliminary data

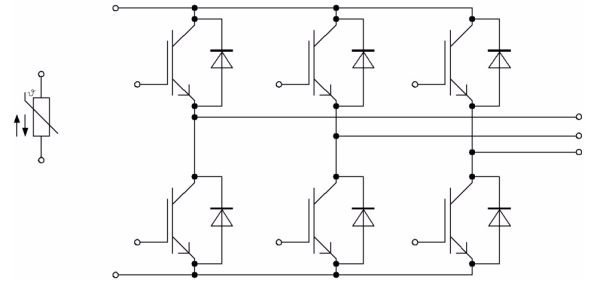
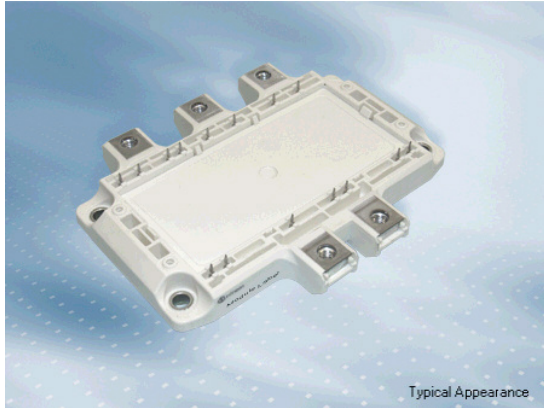

V_{CEs} = 1200V
I_{C nom} = 100A / I_{CRM} = 200A

Typische Anwendungen

- Hochleistungsumrichter
- Motorantriebe
- USV-Systeme

Typical Applications

- High Power Converters
- Motor Drives
- UPS Systems

Elektrische Eigenschaften

- Erweiterte Sperrschichttemperatur T_{vj op}
- Niedrige Schaltverluste
- Niedriges V_{CEsat}
- V_{CEsat} mit positivem Temperaturkoeffizienten

Electrical Features

- Extended Operation Temperature T_{vj op}
- Low Switching Losses
- Low V_{CEsat}
- V_{CEsat} with positive Temperature Coefficient

Mechanische Eigenschaften

- Isolierte Bodenplatte
- Standardgehäuse

Mechanical Features

- Isolated Base Plate
- Standard Housing

Module Label Code

Barcode Code 128



DMX - Code



Content of the Code

	Digit
Module Serial Number	1 - 5
Module Material Number	6 - 11
Production Order Number	12 - 19
Datecode (Production Year)	20 - 21
Datecode (Production Week)	22 - 23

prepared by: MK	date of publication: 2012-01-12	material no: 35981
approved by: MK	revision: 2.2	UL approved (E83335)

IGBT-Wechselrichter / IGBT-inverter

Höchstzulässige Werte / Maximum Rated Values

Kollektor-Emitter-Sperrspannung Collector-emitter voltage	$T_{vj} = 25^{\circ}\text{C}$	V_{CES}	1200	V
Kollektor-Dauergleichstrom Continuous DC collector current	$T_C = 90^{\circ}\text{C}, T_{vj} = 175^{\circ}\text{C}$ $T_C = 25^{\circ}\text{C}, T_{vj} = 175^{\circ}\text{C}$	$I_{C\text{ nom}}$ I_C	100 135	A A
Periodischer Kollektor-Spitzenstrom Repetitive peak collector current	$t_p = 1\text{ ms}$	I_{CRM}	200	A
Gesamt-Verlustleistung Total power dissipation	$T_C = 25^{\circ}\text{C}, T_{vj} = 175^{\circ}\text{C}$	P_{tot}	500	W
Gate-Emitter-Spitzenspannung Gate-emitter peak voltage		V_{GES}	+/-20	V

Charakteristische Werte / Characteristic Values

			min.	typ.	max.		
Kollektor-Emitter-Sättigungsspannung Collector-emitter saturation voltage	$I_C = 100\text{ A}, V_{GE} = 15\text{ V}$ $I_C = 100\text{ A}, V_{GE} = 15\text{ V}$ $I_C = 100\text{ A}, V_{GE} = 15\text{ V}$	$T_{vj} = 25^{\circ}\text{C}$ $T_{vj} = 125^{\circ}\text{C}$ $T_{vj} = 150^{\circ}\text{C}$	$V_{CE\text{ sat}}$	1,75 2,05 2,10	2,15	V V V	
Gate-Schwellenspannung Gate threshold voltage	$I_C = 3,80\text{ mA}, V_{CE} = V_{GE}, T_{vj} = 25^{\circ}\text{C}$		V_{GEth}	5,2	5,8	6,4	V
Gateladung Gate charge	$V_{GE} = -15\text{ V} \dots +15\text{ V}$		Q_G	0,80			μC
Interner Gatewiderstand Internal gate resistor	$T_{vj} = 25^{\circ}\text{C}$		R_{Gint}	7,5			Ω
Eingangskapazität Input capacitance	$f = 1\text{ MHz}, T_{vj} = 25^{\circ}\text{C}, V_{CE} = 25\text{ V}, V_{GE} = 0\text{ V}$		C_{ies}	6,30			nF
Rückwirkungskapazität Reverse transfer capacitance	$f = 1\text{ MHz}, T_{vj} = 25^{\circ}\text{C}, V_{CE} = 25\text{ V}, V_{GE} = 0\text{ V}$		C_{res}	0,27			nF
Kollektor-Emitter-Reststrom Collector-emitter cut-off current	$V_{CE} = 1200\text{ V}, V_{GE} = 0\text{ V}, T_{vj} = 25^{\circ}\text{C}$		I_{CES}			1,0	mA
Gate-Emitter-Reststrom Gate-emitter leakage current	$V_{CE} = 0\text{ V}, V_{GE} = 20\text{ V}, T_{vj} = 25^{\circ}\text{C}$		I_{GES}			100	nA
Einschaltverzögerungszeit, induktive Last Turn-on delay time, inductive load	$I_C = 100\text{ A}, V_{CE} = 600\text{ V}$ $V_{GE} = \pm 15\text{ V}$ $R_{Gon} = 1,6\ \Omega$	$T_{vj} = 25^{\circ}\text{C}$ $T_{vj} = 125^{\circ}\text{C}$ $T_{vj} = 150^{\circ}\text{C}$	$t_{d\text{ on}}$	0,14 0,15 0,15			μs μs μs
Anstiegszeit, induktive Last Rise time, inductive load	$I_C = 100\text{ A}, V_{CE} = 600\text{ V}$ $V_{GE} = \pm 15\text{ V}$ $R_{Gon} = 1,6\ \Omega$	$T_{vj} = 25^{\circ}\text{C}$ $T_{vj} = 125^{\circ}\text{C}$ $T_{vj} = 150^{\circ}\text{C}$	t_r	0,03 0,035 0,04			μs μs μs
Abschaltverzögerungszeit, induktive Last Turn-off delay time, inductive load	$I_C = 100\text{ A}, V_{CE} = 600\text{ V}$ $V_{GE} = \pm 15\text{ V}$ $R_{Goff} = 1,6\ \Omega$	$T_{vj} = 25^{\circ}\text{C}$ $T_{vj} = 125^{\circ}\text{C}$ $T_{vj} = 150^{\circ}\text{C}$	$t_{d\text{ off}}$	0,32 0,40 0,42			μs μs μs
Fallzeit, induktive Last Fall time, inductive load	$I_C = 100\text{ A}, V_{CE} = 600\text{ V}$ $V_{GE} = \pm 15\text{ V}$ $R_{Goff} = 1,6\ \Omega$	$T_{vj} = 25^{\circ}\text{C}$ $T_{vj} = 125^{\circ}\text{C}$ $T_{vj} = 150^{\circ}\text{C}$	t_f	0,09 0,16 0,18			μs μs μs
Einschaltverlustenergie pro Puls Turn-on energy loss per pulse	$I_C = 100\text{ A}, V_{CE} = 600\text{ V}, L_S = 30\text{ nH}$ $V_{GE} = \pm 15\text{ V}, di/dt = 3400\text{ A}/\mu\text{s} (T_{vj}=150^{\circ}\text{C})$ $R_{Gon} = 1,6\ \Omega$	$T_{vj} = 25^{\circ}\text{C}$ $T_{vj} = 125^{\circ}\text{C}$ $T_{vj} = 150^{\circ}\text{C}$	E_{on}	5,20 9,30 10,5			mJ mJ mJ
Abschaltverlustenergie pro Puls Turn-off energy loss per pulse	$I_C = 100\text{ A}, V_{CE} = 600\text{ V}, L_S = 30\text{ nH}$ $V_{GE} = \pm 15\text{ V}, du/dt = 5000\text{ V}/\mu\text{s} (T_{vj}=150^{\circ}\text{C})$ $R_{Goff} = 1,6\ \Omega$	$T_{vj} = 25^{\circ}\text{C}$ $T_{vj} = 125^{\circ}\text{C}$ $T_{vj} = 150^{\circ}\text{C}$	E_{off}	5,50 8,30 9,30			mJ mJ mJ
Kurzschlußverhalten SC data	$V_{GE} \leq 15\text{ V}, V_{CC} = 800\text{ V}$ $V_{CEmax} = V_{CES} - L_{sCE} \cdot di/dt$ $t_p \leq 10\ \mu\text{s}, T_{vj} = 150^{\circ}\text{C}$		I_{SC}	360			A
Wärmewiderstand, Chip bis Gehäuse Thermal resistance, junction to case	pro IGBT / per IGBT		R_{thJC}		0,30		K/W
Wärmewiderstand, Gehäuse bis Kühlkörper Thermal resistance, case to heatsink	pro IGBT / per IGBT $\lambda_{Paste} = 1\text{ W}/(\text{m}\cdot\text{K})$ / $\lambda_{grease} = 1\text{ W}/(\text{m}\cdot\text{K})$		R_{thCH}	0,083			K/W

prepared by: MK	date of publication: 2012-01-12
approved by: MK	revision: 2.2



Vorläufige Daten
Preliminary data

Diode-Wechselrichter / Diode-inverter
Höchstzulässige Werte / Maximum Rated Values

Periodische Spitzensperrspannung Repetitive peak reverse voltage	$T_{vj} = 25^{\circ}\text{C}$	V_{RRM}	1200	V
Dauergleichstrom Continuous DC forward current		I_F	100	A
Periodischer Spitzenstrom Repetitive peak forward current	$t_p = 1 \text{ ms}$	I_{FRM}	200	A
Grenzlastintegral I^2t - value	$V_R = 0 \text{ V}, t_p = 10 \text{ ms}, T_{vj} = 125^{\circ}\text{C}$ $V_R = 0 \text{ V}, t_p = 10 \text{ ms}, T_{vj} = 150^{\circ}\text{C}$	I^2t	1550 1500	A^2s A^2s

Charakteristische Werte / Characteristic Values

			min.	typ.	max.	
Durchlassspannung Forward voltage	$I_F = 100 \text{ A}, V_{GE} = 0 \text{ V}$ $I_F = 100 \text{ A}, V_{GE} = 0 \text{ V}$ $I_F = 100 \text{ A}, V_{GE} = 0 \text{ V}$	$T_{vj} = 25^{\circ}\text{C}$ $T_{vj} = 125^{\circ}\text{C}$ $T_{vj} = 150^{\circ}\text{C}$	V_F	1,70 1,65 1,65	2,15	V V V
Rückstromspitze Peak reverse recovery current	$I_F = 100 \text{ A}, -di_F/dt = 3400 \text{ A}/\mu\text{s} (T_{vj}=150^{\circ}\text{C})$ $V_R = 600 \text{ V}$ $V_{GE} = -15 \text{ V}$	$T_{vj} = 25^{\circ}\text{C}$ $T_{vj} = 125^{\circ}\text{C}$ $T_{vj} = 150^{\circ}\text{C}$	I_{RM}	120 125 130		A A A
Sperrverzögerungsladung Recovered charge	$I_F = 100 \text{ A}, -di_F/dt = 3400 \text{ A}/\mu\text{s} (T_{vj}=150^{\circ}\text{C})$ $V_R = 600 \text{ V}$ $V_{GE} = -15 \text{ V}$	$T_{vj} = 25^{\circ}\text{C}$ $T_{vj} = 125^{\circ}\text{C}$ $T_{vj} = 150^{\circ}\text{C}$	Q_r	9,30 16,5 19,5		μC μC μC
Abschaltenergie pro Puls Reverse recovery energy	$I_F = 100 \text{ A}, -di_F/dt = 3400 \text{ A}/\mu\text{s} (T_{vj}=150^{\circ}\text{C})$ $V_R = 600 \text{ V}$ $V_{GE} = -15 \text{ V}$	$T_{vj} = 25^{\circ}\text{C}$ $T_{vj} = 125^{\circ}\text{C}$ $T_{vj} = 150^{\circ}\text{C}$	E_{rec}	4,10 7,30 8,00		mJ mJ mJ
Wärmewiderstand, Chip bis Gehäuse Thermal resistance, junction to case	pro Diode / per diode		R_{thJC}		0,55	K/W
Wärmewiderstand, Gehäuse bis Kühlkörper Thermal resistance, case to heatsink	pro Diode / per diode $\lambda_{\text{Paste}} = 1 \text{ W}/(\text{m}\cdot\text{K}) / \lambda_{\text{grease}} = 1 \text{ W}/(\text{m}\cdot\text{K})$		R_{thCH}	0,155		K/W

NTC-Widerstand / NTC-thermistor

Charakteristische Werte / Characteristic Values

			min.	typ.	max.	
Nennwiderstand Rated resistance	$T_C = 25^{\circ}\text{C}$		R_{25}	5,00		k Ω
Abweichung von R100 Deviation of R100	$T_C = 100^{\circ}\text{C}, R_{100} = 493 \Omega$		$\Delta R/R$	-5	5	%
Verlustleistung Power dissipation	$T_C = 25^{\circ}\text{C}$		P_{25}		20,0	mW
B-Wert B-value	$R_2 = R_{25} \exp [B_{25/50}(1/T_2 - 1/(298,15 \text{ K}))]$		$B_{25/50}$	3375		K
B-Wert B-value	$R_2 = R_{25} \exp [B_{25/80}(1/T_2 - 1/(298,15 \text{ K}))]$		$B_{25/80}$	3411		K
B-Wert B-value	$R_2 = R_{25} \exp [B_{25/100}(1/T_2 - 1/(298,15 \text{ K}))]$		$B_{25/100}$	3433		K

Angaben gemäß gültiger Application Note.
Specification according to the valid application note.

prepared by: MK	date of publication: 2012-01-12
approved by: MK	revision: 2.2

Technische Information / technical information

IGBT-Module
IGBT-modules

FS100R12PT4



Vorläufige Daten Preliminary data

Modul / Module

Isolations-Prüfspannung Isolation test voltage	RMS, f = 50 Hz, t = 1 min	V _{ISOL}	2,5		kV
Material Modulgrundplatte Material of module baseplate			Cu		
Innere Isolation Internal isolation			Al ₂ O ₃		
Kriechstrecke Creepage distance	Kontakt - Kühlkörper / terminal to heatsink Kontakt - Kontakt / terminal to terminal		25,0 12,5		mm
Luftstrecke Clearance	Kontakt - Kühlkörper / terminal to heatsink Kontakt - Kontakt / terminal to terminal		11,0 7,0		mm
Vergleichszahl der Kriechwegbildung Comperative tracking index		CTI	> 200		
			min.	typ.	max.
Wärmewiderstand, Gehäuse bis Kühlkörper Thermal resistance, case to heatsink	pro Modul / per module $\lambda_{\text{Paste}} = 1 \text{ W}/(\text{m}\cdot\text{K}) / \lambda_{\text{grease}} = 1 \text{ W}/(\text{m}\cdot\text{K})$	R _{thCH}	0,009		K/W
Modulstreinduktivität Stray inductance module		L _{sCE}	20		nH
Modulleitungswiderstand, Anschlüsse - Chip Module lead resistance, terminals - chip	T _C = 25°C, pro Schalter / per switch	R _{CC'+EE'}	1,40		mΩ
Höchstzulässige Sperrschichttemperatur Maximum junction temperature	Wechselrichter, Brems-Chopper / Inverter, Brake-Chopper	T _{vj max}			175 °C
Temperatur im Schaltbetrieb Temperature under switching conditions	Wechselrichter, Brems-Chopper / Inverter, Brake-Chopper	T _{vj op}	-40		150 °C
Lagertemperatur Storage temperature		T _{stg}	-40		125 °C
Anzugsdrehmoment f. Modulmontage Mounting torque for modul mounting	Schraube M5 - Montage gem. gültiger Applikation Note screw M5 - mounting according to valid application note	M	3,00	-	6,00 Nm
Anzugsdrehmoment f. elektr. Anschlüsse Terminal connection torque	Schraube M6 - Montage gem. gültiger Applikation Note screw M6 - mounting according to valid application note	M	3,0	-	6,0 Nm
Gewicht Weight		G	400		g

prepared by: MK	date of publication: 2012-01-12
approved by: MK	revision: 2.2

Vorläufige Daten
Preliminary data

Ausgangskennlinie IGBT-Wechselr. (typisch)
output characteristic IGBT-inverter (typical)
 $I_c = f(V_{CE})$
 $V_{GE} = 15\text{ V}$

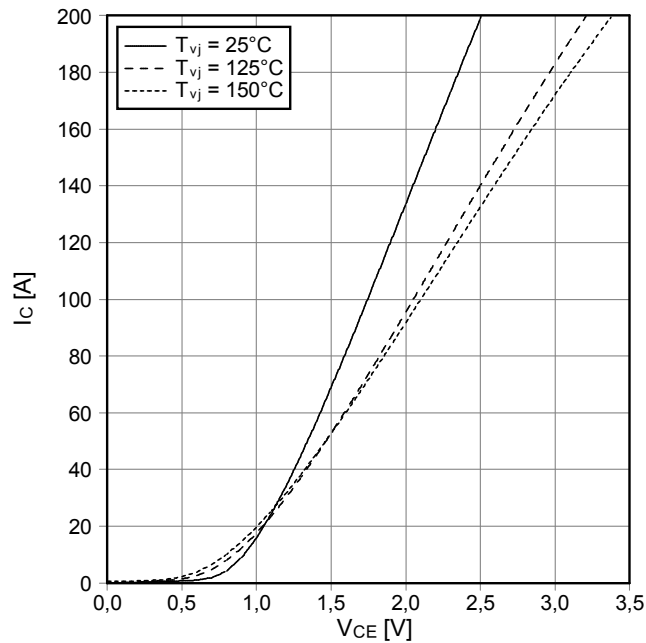

Ausgangskennlinienfeld IGBT-Wechselr. (typisch)
output characteristic IGBT-inverter (typical)
 $I_c = f(V_{CE})$
 $T_{vj} = 150^\circ\text{C}$

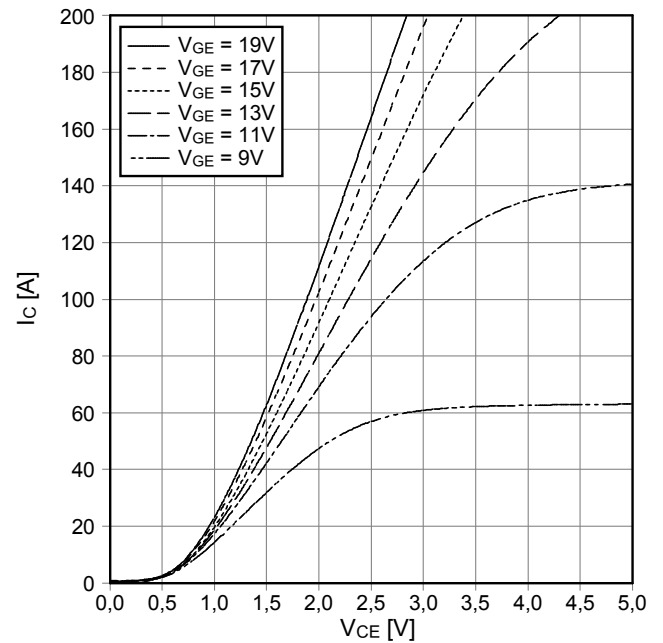

Übertragungscharakteristik IGBT-Wechselr. (typisch)
transfer characteristic IGBT-inverter (typical)
 $I_c = f(V_{GE})$
 $V_{CE} = 20\text{ V}$

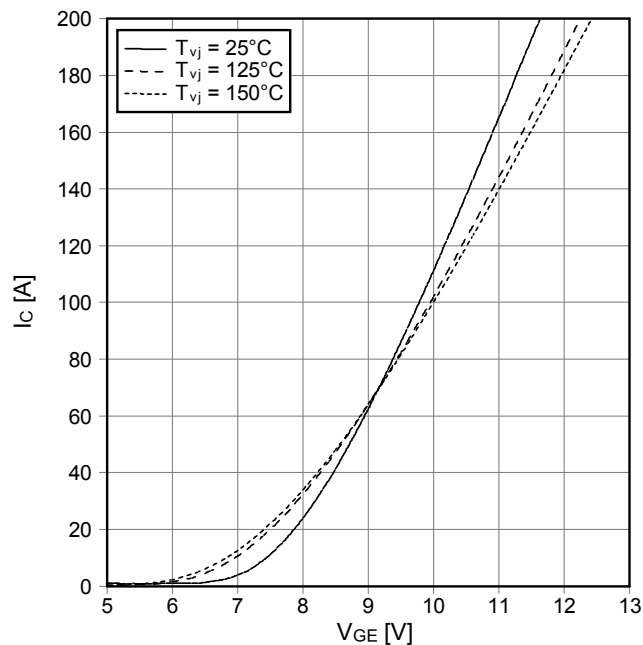

Schaltverluste IGBT-Wechselr. (typisch)
switching losses IGBT-inverter (typical)
 $E_{on} = f(I_c), E_{off} = f(I_c)$
 $V_{GE} = \pm 15\text{ V}, R_{Gon} = 1.6\ \Omega, R_{Goff} = 1.6\ \Omega, V_{CE} = 600\text{ V}$

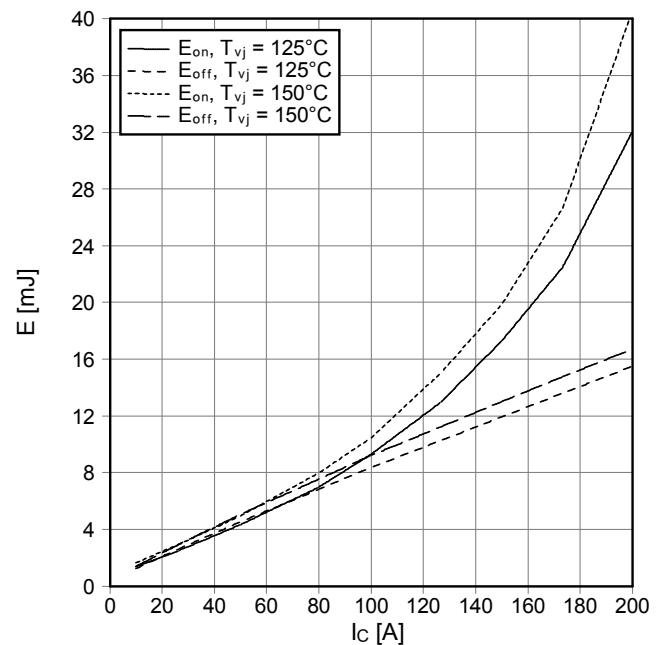

prepared by: MK	date of publication: 2012-01-12
approved by: MK	revision: 2.2



Vorläufige Daten
Preliminary data

Schaltverluste IGBT-Wechselr. (typisch)
switching losses IGBT-inverter (typical)
 $E_{on} = f(R_G)$, $E_{off} = f(R_G)$
 $V_{GE} = \pm 15\text{ V}$, $I_C = 100\text{ A}$, $V_{CE} = 600\text{ V}$

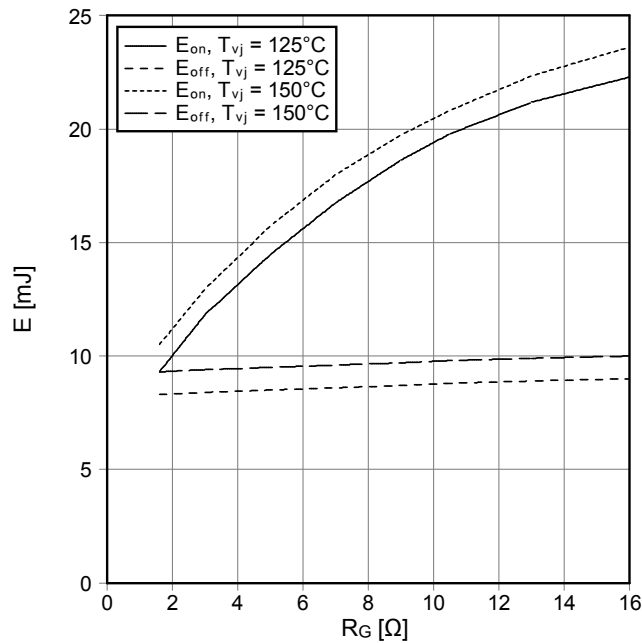

Transienter Wärmewiderstand IGBT-Wechselr.
transient thermal impedance IGBT-inverter
 $Z_{thJC} = f(t)$

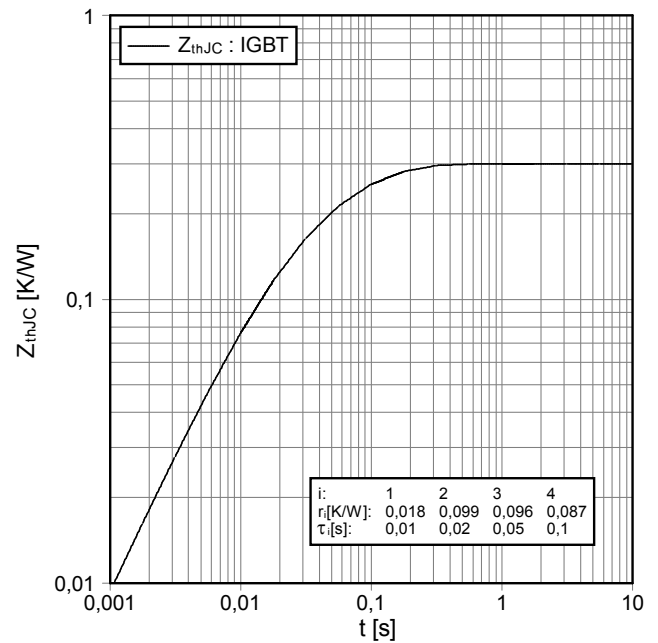

Sicherer Rückwärts-Arbeitsbereich IGBT-Wr. (RBSOA)
reverse bias safe operating area IGBT-inv. (RBSOA)
 $I_C = f(V_{CE})$
 $V_{GE} = \pm 15\text{ V}$, $R_{Goff} = 1.6\ \Omega$, $T_{vj} = 150^\circ\text{C}$

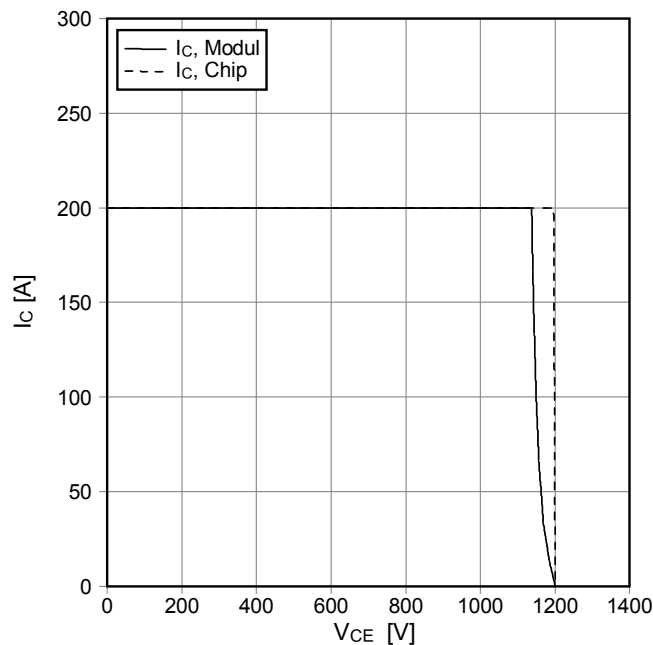

Durchlasskennlinie der Diode-Wechselr. (typisch)
forward characteristic of diode-inverter (typical)
 $I_F = f(V_F)$

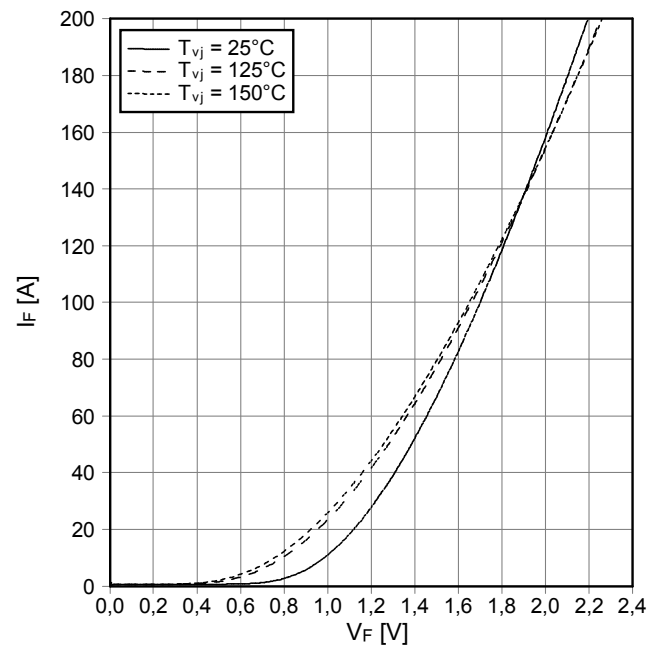

prepared by: MK	date of publication: 2012-01-12
approved by: MK	revision: 2.2



Vorläufige Daten
Preliminary data

Schaltverluste Diode-Wechselr. (typisch)
switching losses diode-inverter (typical)

$E_{rec} = f(I_F)$
 $R_{Gon} = 1.6 \Omega, V_{CE} = 600 V$

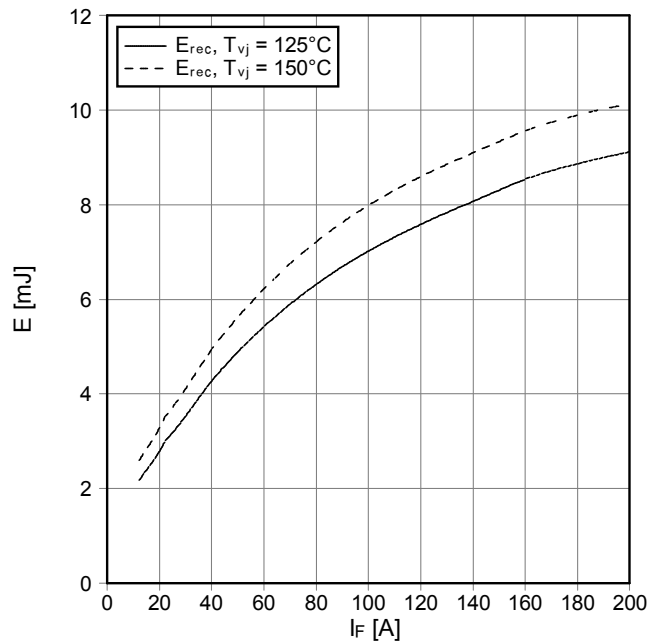

Schaltverluste Diode-Wechselr. (typisch)
switching losses diode-inverter (typical)

$E_{rec} = f(R_G)$
 $I_F = 100 A, V_{CE} = 600 V$

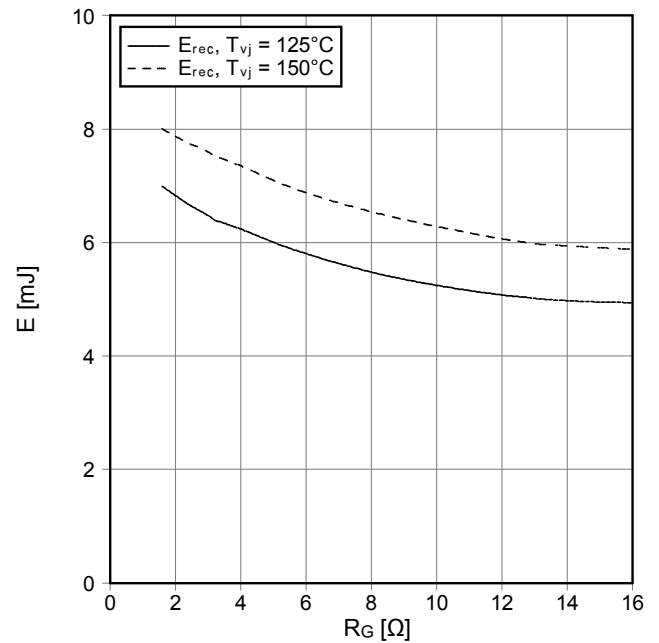

Transienter Wärmewiderstand Diode-Wechselr.
transient thermal impedance diode-inverter

$Z_{thJC} = f(t)$

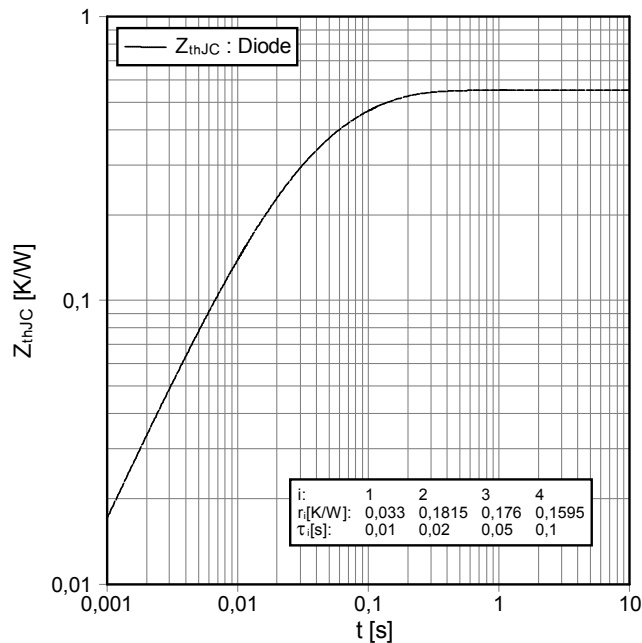

NTC-Temperaturkennlinie (typisch)
NTC-temperature characteristic (typical)

$R = f(T)$

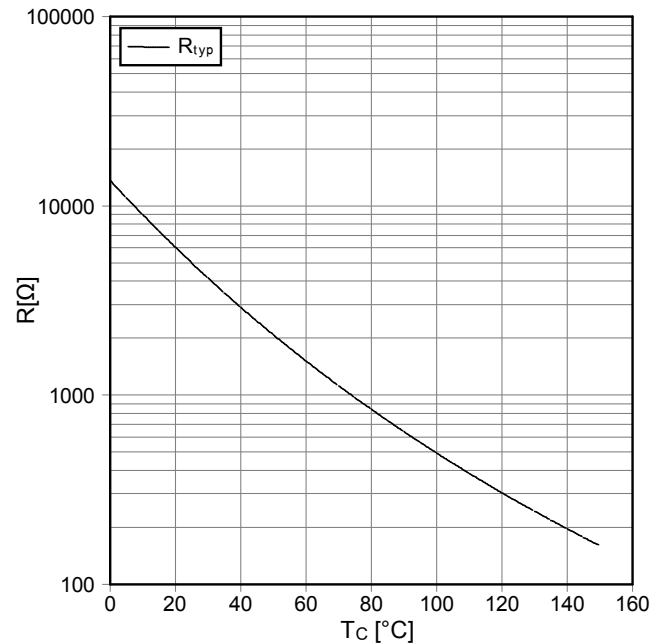

prepared by: MK	date of publication: 2012-01-12
approved by: MK	revision: 2.2

Schaltplan / circuit diagram

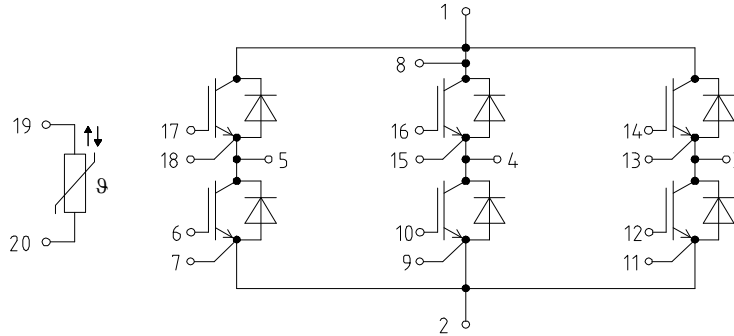

Gehäuseabmessungen / package outlines

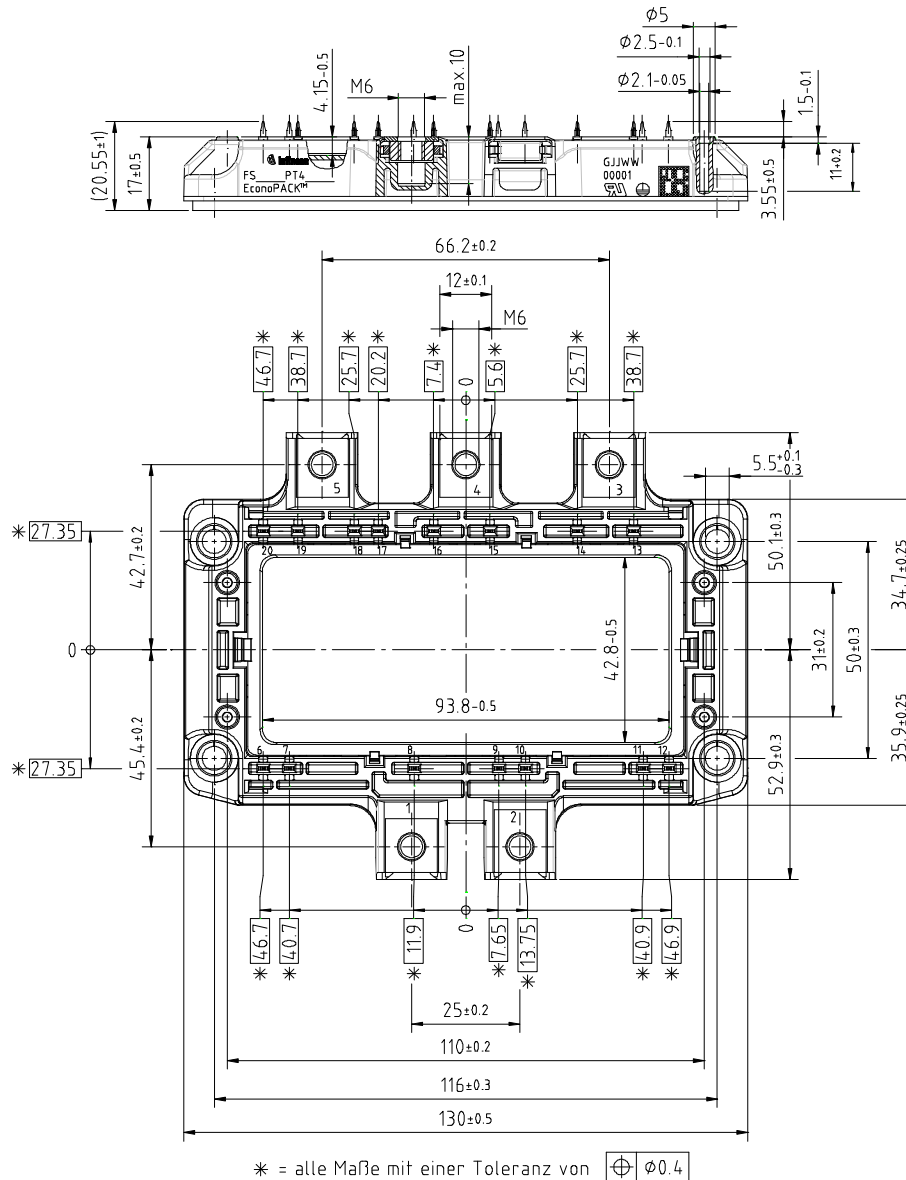

prepared by: MK
approved by: MK

date of publication: 2012-01-12
revision: 2.2



Nutzungsbedingungen

Die in diesem Produktdatenblatt enthaltenen Daten sind ausschließlich für technisch geschultes Fachpersonal bestimmt. Die Beurteilung der Eignung dieses Produktes für Ihre Anwendung sowie die Beurteilung der Vollständigkeit der bereitgestellten Produktdaten für diese Anwendung obliegt Ihnen bzw. Ihren technischen Abteilungen.

In diesem Produktdatenblatt werden diejenigen Merkmale beschrieben, für die wir eine liefervertragliche Gewährleistung übernehmen. Eine solche Gewährleistung richtet sich ausschließlich nach Maßgabe der im jeweiligen Liefervertrag enthaltenen Bestimmungen. Garantien jeglicher Art werden für das Produkt und dessen Eigenschaften keinesfalls übernommen.

Sollten Sie von uns Produktinformationen benötigen, die über den Inhalt dieses Produktdatenblatts hinausgehen und insbesondere eine spezifische Verwendung und den Einsatz dieses Produktes betreffen, setzen Sie sich bitte mit dem für Sie zuständigen Vertriebsbüro in Verbindung (siehe www.infineon.com, Vertrieb&Kontakt). Für Interessenten halten wir Application Notes bereit.

Aufgrund der technischen Anforderungen könnte unser Produkt gesundheitsgefährdende Substanzen enthalten. Bei Rückfragen zu den in diesem Produkt jeweils enthaltenen Substanzen setzen Sie sich bitte ebenfalls mit dem für Sie zuständigen Vertriebsbüro in Verbindung.

Sollten Sie beabsichtigen, das Produkt in Anwendungen der Luftfahrt, in gesundheits- oder lebensgefährdenden oder lebenserhaltenden Anwendungsbereichen einzusetzen, bitten wir um Mitteilung. Wir weisen darauf hin, dass wir für diese Fälle

- die gemeinsame Durchführung eines Risiko- und Qualitätsassessments;
- den Abschluss von speziellen Qualitätssicherungsvereinbarungen;
- die gemeinsame Einführung von Maßnahmen zu einer laufenden Produktbeobachtung dringend empfehlen und gegebenenfalls die Belieferung von der Umsetzung solcher Maßnahmen abhängig machen.

Soweit erforderlich, bitten wir Sie, entsprechende Hinweise an Ihre Kunden zu geben.

Inhaltliche Änderungen dieses Produktdatenblatts bleiben vorbehalten.

Terms & Conditions of usage

The data contained in this product data sheet is exclusively intended for technically trained staff. You and your technical departments will have to evaluate the suitability of the product for the intended application and the completeness of the product data with respect to such application.

This product data sheet is describing the characteristics of this product for which a warranty is granted. Any such warranty is granted exclusively pursuant the terms and conditions of the supply agreement. There will be no guarantee of any kind for the product and its characteristics.

Should you require product information in excess of the data given in this product data sheet or which concerns the specific application of our product, please contact the sales office, which is responsible for you (see www.infineon.com, sales&contact). For those that are specifically interested we may provide application notes.

Due to technical requirements our product may contain dangerous substances. For information on the types in question please contact the sales office, which is responsible for you.

Should you intend to use the Product in aviation applications, in health or live endangering or life support applications, please notify. Please note, that for any such applications we urgently recommend

- to perform joint Risk and Quality Assessments;
- the conclusion of Quality Agreements;
- to establish joint measures of an ongoing product survey, and that we may make delivery depended on the realization of any such measures.

If and to the extent necessary, please forward equivalent notices to your customers.

Changes of this product data sheet are reserved.

prepared by: MK	date of publication: 2012-01-12
approved by: MK	revision: 2.2